

**SAMSUNG**  
WiSeNET

# **AHD SPEED DOME CAMERA**

User Manual

HCP-6320/HCP-6320H

CE

# AHD SPEED DOME CAMERA

## User Manual

---

### Copyright

© 2016 Hanwha Techwin Co., Ltd. All rights reserved.

### Trademark

Each of trademarks herein is registered. The name of this product and other trademarks mentioned in this manual are the registered trademark of their respective company.

### Restriction

Copyright of this document is reserved. Under no circumstances, this document shall be reproduced, distributed or changed, partially or wholly, without formal authorization.

### Disclaimer

Hanwha Techwin makes the best to verify the integrity and correctness of the contents in this document, but no formal guarantee shall be provided. Use of this document and the subsequent results shall be entirely on the user's own responsibility.

Hanwha Techwin reserves the right to change the contents of this document without prior notice.

❖ Design and specifications are subject to change without prior notice.

# safety information



## CAUTION

RISK OF ELECTRIC SHOCK.  
DO NOT OPEN



**CAUTION:** TO REDUCE THE RISK OF ELECTRIC SHOCK, DO NOT REMOVE COVER (OR BACK) NO USER SERVICEABLE PARTS INSIDE. REFER SERVICING TO QUALIFIED SERVICE PERSONNEL.



This symbol indicates that dangerous voltage consisting a risk of electric shock is present within this unit.



This symbol indicates that there are important operating and maintenance instructions in the literature accompanying this unit.

## WARNING

- To reduce the risk of fire or electric shock, do not expose this appliance to rain or moisture.
- To prevent injury, this apparatus must be securely attached to the floor/wall in accordance with the installation instructions.
- Do NOT use power sources other than Class 2 power source.
- REPLACE WITH SAME TYPE 250V T3.15AL FUSE(F1)

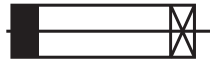

## WARNING

1. Be sure to use only the standard adapter that is specified in the specification sheet. Using any other adapter could cause fire, electrical shock, or damage to the product.
2. Incorrectly connecting the power supply or replacing battery may cause explosion, fire, electric shock, or damage to the product.
3. Do not connect multiple cameras to a single adapter. Exceeding the capacity may cause abnormal heat generation or fire.
4. Securely plug the power cord into the power receptacle. Insecure connection may cause fire.
5. When installing the camera, fasten it securely and firmly. The fall of camera may cause personal injury.
6. Do not place conductive objects (e.g. screwdrivers, coins, metal parts, etc.) or containers filled with water on top of the camera. Doing so may cause personal injury due to fire, electric shock, or falling objects.
7. Do not install the unit in humid, dusty, or sooty locations. Doing so may cause fire or electric shock.
8. If any unusual smells or smoke come from the unit, stop using the product. In such case, immediately disconnect the power source and contact the service center. Continued use in such a condition may cause fire or electric shock.
9. If this product fails to operate normally, contact the nearest service center. Never disassemble or modify this product in any way. (Hanwha Techwin is not liable for problems caused by unauthorized modifications or attempted repair.
10. When cleaning, do not spray water directly onto parts of the product. Doing so may cause fire or electric shock.

**CAUTION** - Danger of explosion if battery is incorrectly replaced. Replace only with the same or equivalent type.

## CAUTION

1. Do not drop objects on the product or apply strong blows to it. Keep away from a location subject to excessive vibration or magnetic interference.
2. Do not install in a location subject to high temperature (over 55°C), low temperature (below -50°C), or high humidity. Doing so may cause fire or electric shock.
3. If you want to relocate the already installed product, be sure to turn off the power and then move or reinstall it.
4. Remove the power plug from the outlet when there is a lightning storm. Neglecting to do so may cause fire or damage to the product.

# safety information

---

5. Keep out of direct sunlight and heat radiation sources. It may cause fire.
6. Install it in a place with good ventilation.
7. Avoid aiming the camera directly towards extremely bright objects such as sun, as this may damage the CCD image sensor.
8. Apparatus shall not be exposed to dripping or splashing and no objects filled with liquids, such as vases, shall be placed on the apparatus.
9. Do not expose the camera to radioactivity. Radioactivity exposure may damage the CMOS.

## FCC Statement

This device complies with part 15 of the FCC Rules. Operation is subject to the following two conditions :

- 1) This device may not cause harmful interference, and
- 2) This device must accept any interference received including interference that may cause undesired operation.

## CAUTION

This equipment has been tested and found to comply with the limits for a Class A digital device, pursuant to part 15 of FCC Rules. These limits are designed to provide reasonable protection against harmful interference when the equipment is operated in a commercial environment.

This equipment generates, uses, and can radiate radio frequency energy and, if not installed and used in accordance with the instruction manual, may cause harmful interference to radio communications. Operation of this equipment in a residential area is likely to cause harmful interference in which case the user will be required to correct the interference at his own expense.



## IC Compliance Notice

This Class A digital apparatus meets all requirements of the Canadian Interference.-Causing Equipment Regulations of ICES-003.

## Correct Disposal of This Product (Waste Electrical & Electronic Equipment)



(Applicable in the European Union and other European countries with separate collection systems)

This marking on the product, accessories or literature indicates that the product and its electronic accessories (e.g. charger, headset, USB cable) should not be disposed of with other household waste at the end of their working life. To prevent possible harm to the environment or human health from uncontrolled waste disposal, please separate these items from other types of waste and recycle them responsibly to promote the sustainable reuse of material resources.

Household users should contact either the retailer where they purchased this product, or their local government office, for details of where and how they can take these items for environmentally safe recycling. Business users should contact their supplier and check the terms and conditions of the purchase contract. This product and its electronic accessories should not be mixed with other commercial wastes for disposal.

## Correct disposal of batteries in this product



(Applicable in the European Union and other European countries with separate battery return systems.)

This marking on the battery, manual or packaging indicates that the batteries in this product should not be disposed of with other household waste at the end of their working life. Where marked, the chemical symbols Hg, Cd or Pb indicate that the battery contains mercury, cadmium or lead above the reference levels in EC Directive 2006/66. If batteries are not properly disposed of, these substances can cause harm to human health or the environment.

To protect natural resources and to promote material reuse, please separate batteries from other types of waste and recycle them through your local, free battery return system.

## CAUTION

RISK OF EXPLOSION IF BATTERY IS REPLACED BY AN INCORRECT TYPE.

DISPOSE OF USED BATTERIES ACCORDING TO THE INSTRUCTIONS



# important safety instructions

1. Read these instructions.
2. Keep these instructions.
3. Heed all warnings.
4. Follow all instructions.
5. Do not use this apparatus near water.
6. Clean only with dry cloth.
7. Do not block any ventilation openings, Install in accordance with the manufacturer's instructions.
8. Do not install near any heat sources such as radiators, heat registers, stoves, or other apparatus (including amplifiers) that produce heat.
9. Do not defeat the safety purpose of the polarized or grounding-type plug. A polarized plug has two blades with one wider than the other. A grounding type plug has two blades and a third grounding prong. The wide blade or the third prong are provided for your safety. If the provided plug does not fit into your outlet, consult an electrician for replacement of the obsolete outlet.
10. Protect the power cord from being walked on or pinched particularly at plugs, convenience receptacles, and the point where they exit from the apparatus.
11. Only use attachments/ accessories specified by the manufacturer.
12. Use only with the cart, stand, tripod, bracket, or table specified by the manufacturer, or sold with the apparatus. When a cart is used, use caution when moving the cart/apparatus combination to avoid injury from tip-over.
13. Unplug this apparatus during lighting storms or when unused for long periods of time.
14. Refer all servicing to qualified service personnel. Servicing is required when the apparatus has been damaged in any way, such as power-supply cord or plug is damaged, liquid has been spilled or objects have fallen into the apparatus, the apparatus has been exposed to rain or moisture, does not operate normally, or has been dropped.



Apparatus shall not be exposed to dripping or splashing and no objects filled with liquids, such as vases, shall be placed on the apparatus

## WARNING

To prevent injury, this apparatus must be securely attached to the floor/wall in accordance with the installation instructions.

## CAUTION

These servicing instructions are for use by qualified service personnel only. To reduce the risk of electric shock, do not perform any servicing other than that contained in the operating instructions unless you are qualified to do so.

## DETAILED WARNINGS AND CAUTIONS

---

- Avoid operating the camera for long durations under high temperatures and in high humidity. Excessive heat can shorten the lifespan of the camera components.
- Do not install or place the camera near any heat sources.
- Subjecting the dome cover to physical shock may damage the camera and cause water leakage into it.
- Do not place the camera facing direct sunlight or other intense light sources. Strong lights such as spotlights can cause distortions—blooming and smear—as well as discolorations on the screen by heating up the color filter of the camera. They also may cause internal reflections of the camera, leading to operational malfunctions.
- Do not drop the camera or subject it to physical shock or vibration; this can cause serious damage to the camera.
- When installing the camera near a power line, make sure to keep at least 1 meter distance from the power line, or earth an additional metal pipe to separate the camera from the power source.
- Install this camera on the ceiling. Installing it on the ground or a unlevelled location may cause product malfunctions and shorten its lifespan.
- Avoid installing and operating the camera in the following places.
  - Places whose temperature exceed the camera's recommended range.  
(Indoor : -10°C ~ 55°C, Environmental : -50°C~ 55°C)
  - Places where drastic temperature changes occur: e.g. Near an air conditioner.
  - Places that are exposed to steam, oil, and inflammable substances: e.g. Inside a kitchen.
  - Places that are exposed to radioactivity, X-rays, strong electric waves, and electro-magnetic waves.
  - Places that are exposed to outdoor air contaminants: e.g. Dust and car exhaust.
  - Places in high humidity.
  - Places that are exposed to corrosive gas: e.g. Next to the sea.
- Smearred and dusty dome covers decrease the picture and video quality. Clean the dome cover and camera lens on a regular basis.
- Remove the plastic wrap on the dome cover only after the camera installation is complete.
- This camera is not equipped with a power switch. Plug in the camera only after the installation is complete.

## CAUTIONS FOR OPERATING TEMPERATURE (FOR ENVIRONMENTAL MODELS)

1. The camera cannot operate properly at temperatures lower than  $-50^{\circ}\text{C}$ .
2. If the product is kept at a low temperature, it may take a max of 2 hours to warm up for normal operation.
3. If the camera was turned on after being left at temperatures lower than  $-50^{\circ}\text{C}$  for a long duration:
  - If the internal temperature is lower than  $-20^{\circ}\text{C}$ , the camera does not transmit video signals and displays a black screen along with the "Wait to warm up(xx Left)" message, instead of operating properly.
  - If the internal temperature is higher than  $-20^{\circ}\text{C}$  and lower than  $-10^{\circ}\text{C}$ , the "Wait to warm up(xx Left)" message disappears as the camera resets itself and enters the operation mode.  
However, only manual P/T operation is in effect while the Sequence and Turbo commands are limited in use.
  - If the internal temperature is higher than  $-10^{\circ}\text{C}$ , the camera activates all Sequence and Turbo commands.
4. The speed of the horizontal/vertical rotation will be deteriorated than normal at below  $-10^{\circ}\text{C}$  degrees for the indoor model, and at below  $-40^{\circ}\text{C}$  degrees for the environmental model.
5. If the heater malfunctions, a message appears as follows.
  - "Please Check Heater System"
  - If this message appears, turn off the camera and call where you bought.



**Hanwha Techwin** cares for the environment at all product manufacturing stages, and is taking measures to provide customers with more environmentally friendly products. The Eco mark represents **Hanwha Techwin**'s devotion to creating environmentally friendly products, and indicates that the product satisfies the EU RoHS Directive.

# contents

---

## INTRODUCTION

9

- 9 Features
- 10 What's included
- 12 Component Names and Functions (Indoor Model)
- 14 Component Names and Functions (Environmental model)

## CONNECTION & INSTALLATION

16

- 16 Camera Wiring Interface Board
- 17 Camera and Appliances Wiring Diagram
- 19 How to Set Up Protocols and ID DIP Switches
- 20 Communication Protocol DIP Switch Settings (SW2)
- 23 Camera ID DIP Switch Settings (SW1)
- 31 Preparing Adapter and Cables
- 32 Product Configurations
- 33 Preparing & Installing Camera Bracket
- 34 Optional Accessories for Installation
- 37 On-Ceiling Mount Type Installation Example
- 40 Example of installing an Environmental model

## SETUP

44

- 44 Interface Symbols
- 45 Using and setting the menus
- 46 OSD Menu Chart
- 47 Camera Setup
- 57 Sequence Setting
- 69 P/T Setting
- 77 OSD Setting
- 78 Alarm Setting
- 81 Initialize
- 82 Password setting
- 82 Status

## TROUBLESHOOTING

83

- 83 Troubleshooting

## PRODUCT SPECIFICATIONS

87

- 87 Product Specifications
- 90 Dimensions

## FEATURES

---

- **A/F 32x Optical Zoom**

The built-in 32x optical zoom lens with auto-focus is combined with a 16x digital zoom, providing a maximum of 512 zoom.

- **Versatile protocols**

RS-422/485 communication methods are supported.

- RS-422/485 (10 species) : Auto Detected, SAMSUNG-T, SAMSUNG-E, Pelco (D/P), Panasonic, Vicon, Honeywell, AD, GE, BOSCH

- **Wide Range Auto Security Functions**

- Multiple Preset Function Saving : Up to 12 camera image properties can be saved individually to provide high quality pictures.

- Image Holding : When moving in a group tour, the screen appears in a still image until the movement is complete, thus reducing the optical fatigue of the observer.

- PTZ Trace : Patterns operated with the joystick can be saved and replayed by users.

- Swing : Using the Swing function commands the camera to move between 2 selected locations, monitoring the route.

- Group Search : Maximum 128 Preset positions are toured in order.

- Tour Search : Maximum 6 Group Search functions are toured in order.

- **Digital Flip**

The Digital Flip function is useful to monitor moving objects or people passing directly under the camera. When an object or a person passes directly under the camera, its tilt motor follows the object or person over 90 degrees to the other side of the tilt area without panning. The screen inversion starts to occur at 90 degrees or higher is digitally adjusted.

- **Smart P/T**

The Smart P/T function automatically adjusts the control speed of the Pan and Tilt functions according to the current zoom ratio. It is useful to adjust the functions manually for detailed controls when monitoring at high zoom ratios.

- **Day & Night**

With its daytime & nighttime switch and Sens-Up functions based on the ICR (Infrared Cut filter Removal) method, the camera provides high quality pictures regardless of whether it is day or night.

- Sens-Up increases the CMOS sensitivity by electrically extending the camera's exposure time.

- Day & Night enables you to select between color and B/W modes depending on the lighting conditions.

- **Highly durable built-in housing**

This IP66-rated built-in housing is easy to install, and protects the product from a full range of harsh outside conditions. The high performance built-in fan/heater enables the product to operate under extreme temperatures between -50°C~ 55°C.

# introduction

---

- **Preset Position Saving and Loading**

Up to 255 preset positions can be set. Using this function saves and brings up the camera feed of a selected monitoring location.

- **Area Masking**

If a monitoring location includes a highly private area, the area can be selectively masked on the screen.

- **Model Specifications**

HCP-632XH

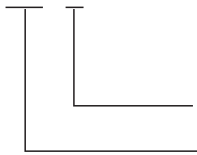



Environmental Model





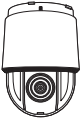
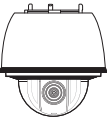

Zoom Factor  
32: 32x Zoom Lens

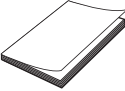
## WHAT'S INCLUDED

---

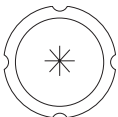
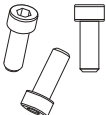
Check if the following items are included in the product package.

Appearance	Item Name	Quantity	Description	Applicable Model
	Main Body	1	-	Indoor Model
		1	-	Environmental Model
	CD Manual	1	Multilingual User Manual and Quick Guide	All
	User Manual or Quick Guide	1	-	

Appearance	Item Name	Quantity	Description	Applicable Model
	Fixing Screw	4	If mounting the install base on the ceiling	Indoor Model
	Installation Template	1	If determining the installation point before mounting the install base on the ceiling	
	Insulation Sheet	1	In the case of installing the camera at highly humid place	
	Hexagon screw	3	Used for attaching the installation base to the camera	Environmental Model
	L Wrench	1	Used for fixing the installation base after attaching it to the camera	
	Bushing pack	1	Used for outdoor installations to prevent from moisture entering.	
	Cable for testing monitor	1	Used to test camera's connection to the portable display device	All

※ For classification of the indoor and environmental models, refer to page 10.

# introduction

---

## COMPONENT NAMES AND FUNCTIONS (INDOOR MODEL)

---

### Appearance

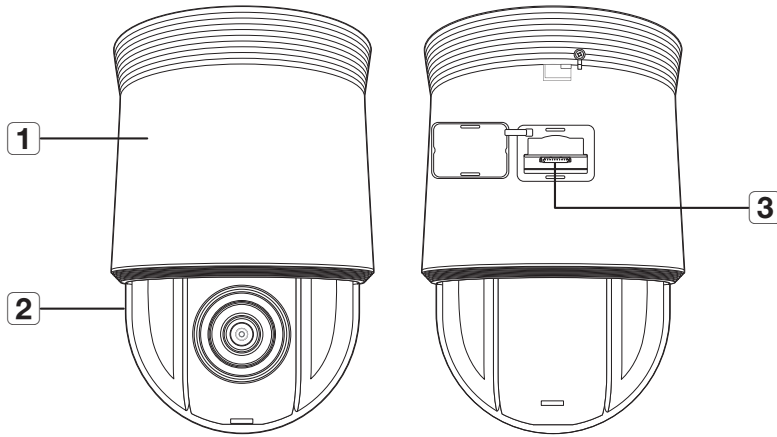

Item	Description
<b>1</b> Main unit	Protects the internal PTZ mechanism from the direct sunlight or external impact.
<b>2</b> Dome Cover	Dome cover for the lens and unit protection.
<b>3</b> After Service Port (A/S port)	This is for the repair purpose only that is not available for the user.



## Bottom View of Installation Base

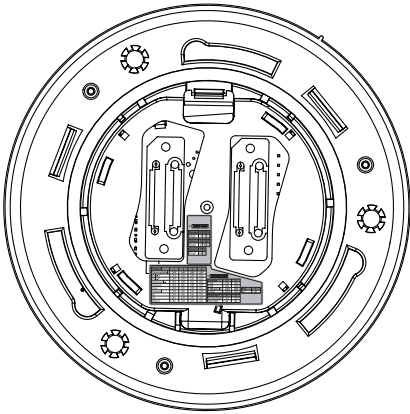

## Inner View of Installation Base

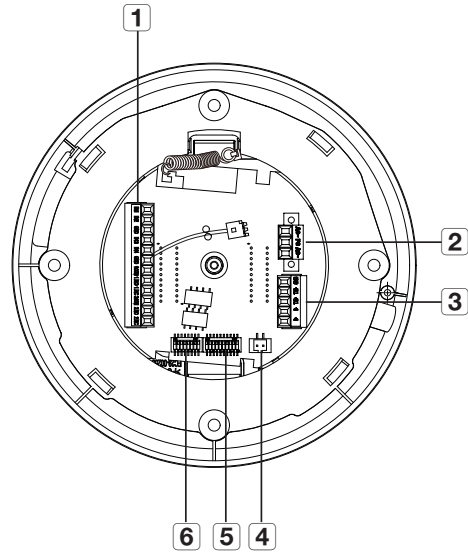

Item	Description
<b>1</b> Alarm I/O Port	Used to connect the alarm I/O cable.
<b>2</b> Power Port	Used to connect the power.
<b>3</b> Communications Ports	Used for RS-485/422 communications.
<b>4</b> Video Out Port	Analog video output port. (for installation)
<b>5</b> Communications Setup Switch	Set the transfer rate and protocols.
<b>6</b> ID Setup Switch	Specify the camera ID.

# introduction

---

## COMPONENT NAMES AND FUNCTIONS (ENVIRONMENTAL MODEL)

---

### Appearance

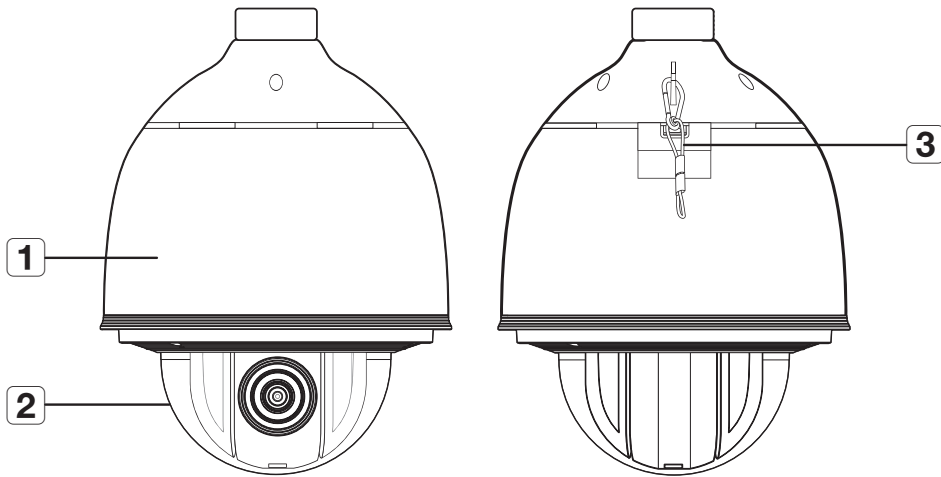

Item	Description
<b>1</b> Main unit	Protects the internal PTZ mechanism from the direct sunlight or external impact.
<b>2</b> Dome Cover	Dome cover for the lens and unit protection.
<b>3</b> Safety Cable	The cable prevents the product from dropping during installation.

## Bottom View of Installation Base

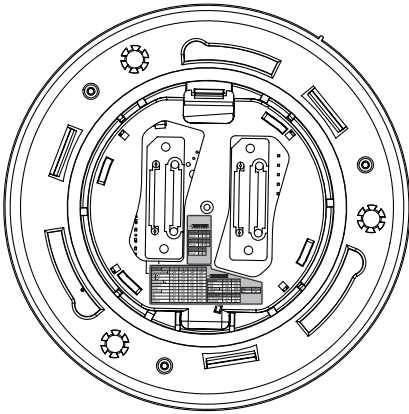

## Inner View of Installation Base

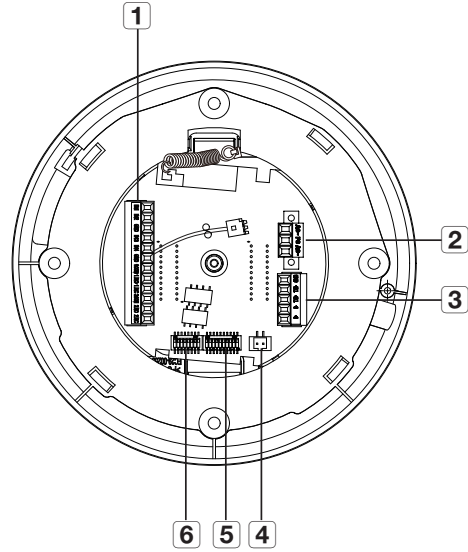

Item	Description
<b>1</b> Alarm I/O Port	Used to connect the alarm I/O cable.
<b>2</b> Power Port	Used to connect the power.
<b>3</b> Communications Ports	Used for RS-485/422 communications.
<b>4</b> Video Out Port	Analog video output port. (for installation)
<b>5</b> Communications Setup Switch	Set the transfer rate and protocols.
<b>6</b> ID Setup Switch	Specify the camera ID.

# connection & installation

## CAMERA WIRING INTERFACE BOARD

For the camera wiring, please refer to the picture below.

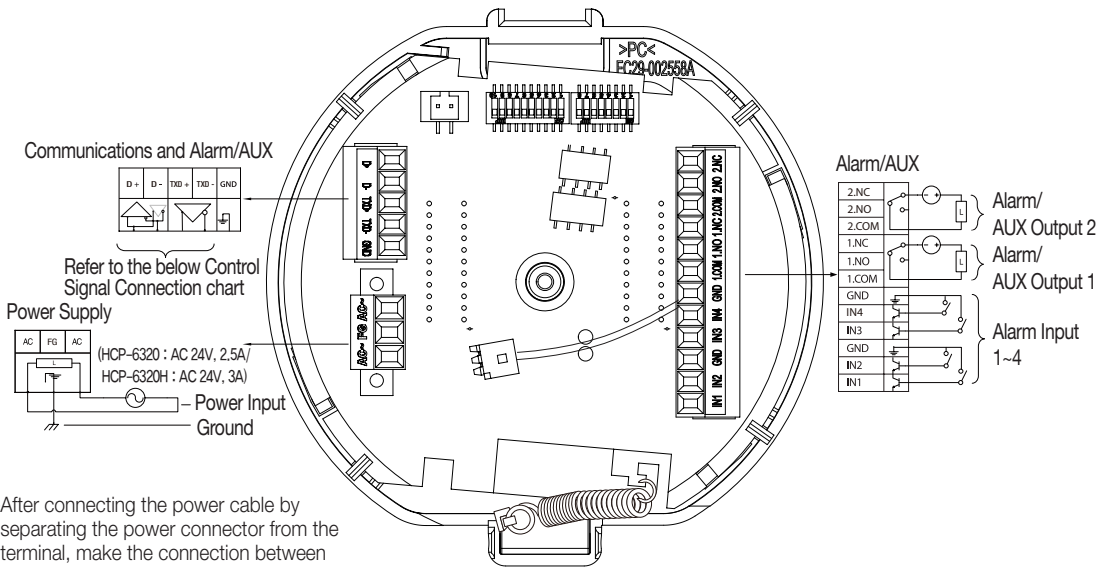

\*After connecting the power cable by separating the power connector from the terminal, make the connection between terminal and connector by using a bolt.

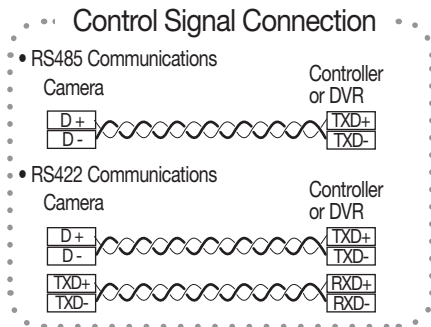

- The max voltage and capacity of the Alarm OUT/AUX OUT ports are 30VDC/2A and 24VAC/2.5A, respectively.
- Connecting the power connector and GND incorrectly to the NC/NO and COM ports may cause a short circuit and fire, damaging the camera.

# CAMERA AND APPLIANCES WIRING DIAGRAM

## Connecting with Samsung's "Stand Alone DVR"

- RS-485 :

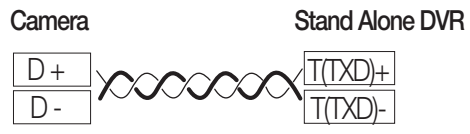

- RS-422 :

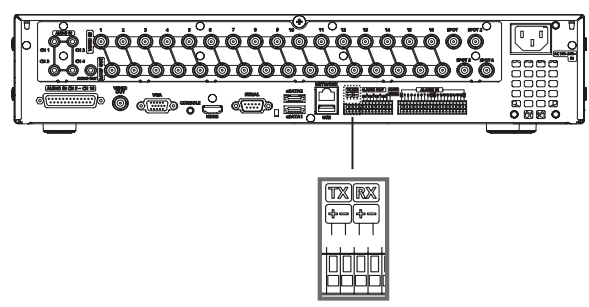
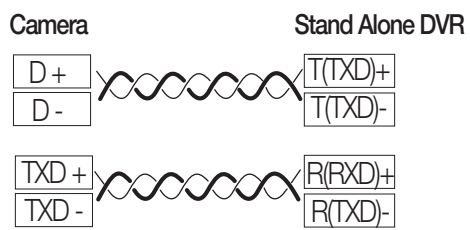

## Connecting with the Samsung Controller SPC-6000

- RS-485 :



- RS-422 :

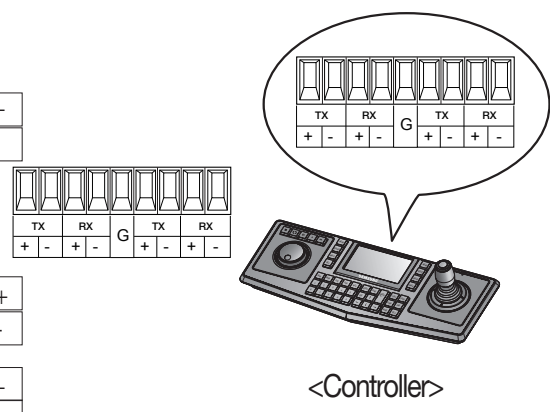
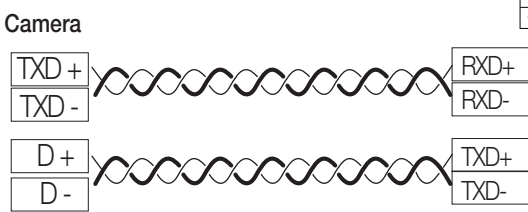

# connection & installation

---

To connect to Samsung PC DVR

- RS-485 :

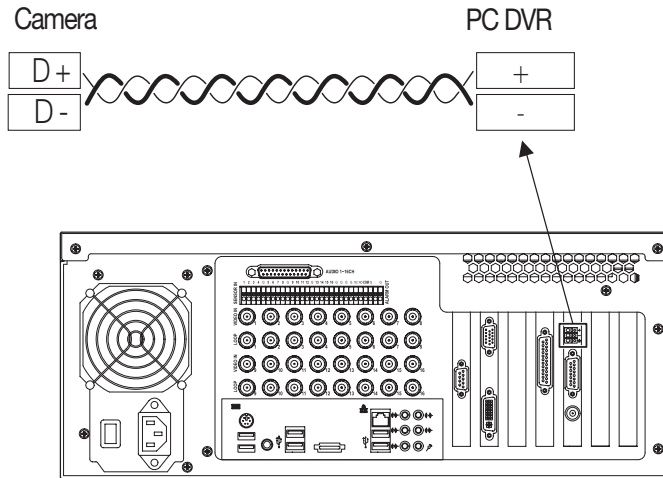

## HOW TO SET UP PROTOCOLS AND ID DIP SWITCHES

You can control various settings of the camera system using the Communication and ID DIP switches. Before installing the product, please set up the DIP switches according to the installation environment.

1. Remove the install base from the camera body and place the part to be headed to the lower end as shown in the figure.
2. Set the switches according to your installation environment. For more detailed setup information, please refer to the chart on the next page.
3. The camera may malfunction if the switches are not fully turned On/Off; please double check the switches before finishing setup.

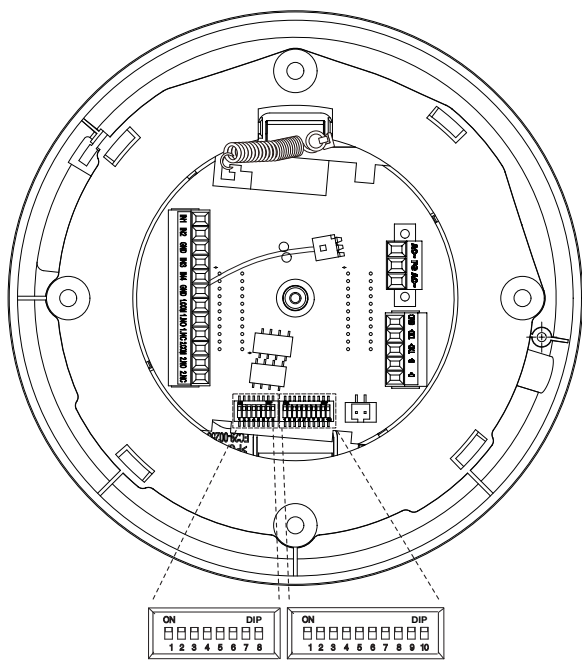

Camera ID DIP Switch (SW1)    Communication Protocol  
DIP Switch(SW2)

# connection & installation

## COMMUNICATION PROTOCOL DIP SWITCH SETTINGS (SW2)

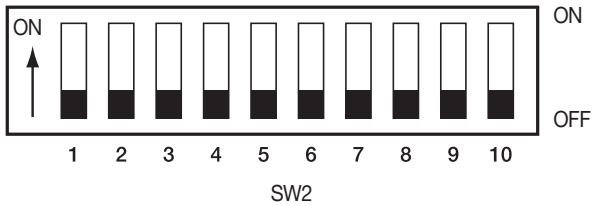

SW2 Pin No.	Purpose
1 ~ 4	Protocol Settings
5~6	Baud Rate Settings
7	Transfer Method (RS-485/422) Settings
8~9	Termination Settings
10	Response Mode Settings

### Protocol Settings

Select a communication protocol for the camera.

No	Protocol	SW2-#1	SW2-#2	SW2-#3	SW2-#4
1	Auto Detected	OFF	OFF	OFF	OFF
2	Samsung-T	OFF	OFF	OFF	ON
3	Samsung-E	OFF	OFF	ON	OFF
4	Pelco-D	OFF	OFF	ON	ON
5	Pelco-P	OFF	ON	OFF	OFF
6	Panasonic	OFF	ON	OFF	ON
7	Vicon	OFF	ON	ON	OFF
8	Honeywell	OFF	ON	ON	ON
9	AD	ON	OFF	OFF	OFF
10	GE	ON	OFF	OFF	ON
11	Bosch	ON	OFF	ON	OFF



### Baud Rate Settings

Select the transfer speed of a selected communication protocol.

No	Baud Rate (BPS)	SW2-#5	SW2-#6
1	2,400	ON	ON
2	4,800	ON	OFF
3	9,600	OFF	OFF
4	19,200	OFF	ON

### Communication Method Settings

Select a communication method for the camera.

	Function	ON	OFF
SW2- #7	Transfer Mode Switch	RS-422 (4Wire)	RS-485 (2Wire)

### Communication Response Settings

Select a communication response method for the camera and controller: Response or No Response.

	Function	ON	OFF
SW2- #10	Response Mode Switch	Response	No Response

### Termination Settings

To prevent the attenuation of communication signals between the camera and controller, the items at the end of line must be set up with the termination settings.

Camera Input Position	SW2- #8	SW2- #9
Termination of Longest Path (RS-422)	ON	ON
Termination of Longest Path (RS-485)	ON	OFF
On the Path	OFF	OFF

### ● Example of terminal setting

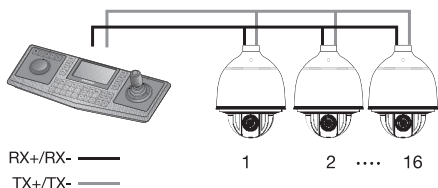

- × If using RS-422, SW2-#8: ON /SW2-#9: ON for camera 16
- × If using RS-485, SW2-#8: ON / SW2-#9: OFF for camera 16

# connection & installation

---



- This model is shipped from the factory with all the communication dip switches (SW2) set to OFF, and the default values are shaded as shown in the setting table.
- If you want to use a third-party controller for controlling the camera, contact us at the call center or visit our website for details.
- AD Protocol Control Method
  1. Input Camera OSD: 3+Auxiliary On
  2. Output Camera OSD: 3+Auxiliary Off
  3. Enter: IRIS Open
  4. ESC: IRIS Close
- For more information about the protocols, refer to our official website.  
<http://www.hanwha-security.com>

## CAMERA ID DIP SWITCH SETTINGS (SW1)

Assign a unique number for each camera to identify itself from others.

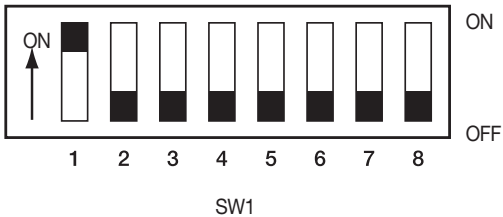

1. The switch is set to "ID: 1" by default, and 7 switches other than switch 1 are all set to OFF.
2. Each switch has a unique value, and the board ID is the sum of the values of the switches.

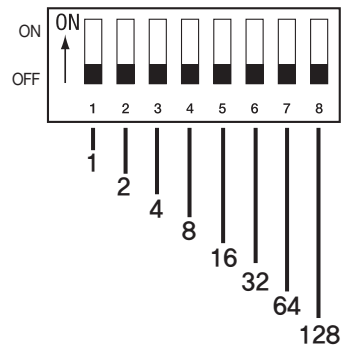

■ Refer to the example below for the board ID.

Example 1	Example 2	Example 3
$1+2 = 3$ (Board ID = 3)	$4+32 = 36$ (Board ID = 36)	$1+2+4+8+16+32+64+128 = 255$ (Board ID = 255)



■ Use a unique ID for each Camera.

# connection & installation

---

## • Camera ID Chart

ID	SW1-#1	SW1-#2	SW1-#3	SW1-#4	SW1-#5	SW1-#6	SW1-#7	SW1-#8
1	OFF	OFF	OFF	OFF	OFF	OFF	OFF	OFF
1	ON	OFF	OFF	OFF	OFF	OFF	OFF	OFF
2	OFF	ON	OFF	OFF	OFF	OFF	OFF	OFF
3	ON	ON	OFF	OFF	OFF	OFF	OFF	OFF
4	OFF	OFF	ON	OFF	OFF	OFF	OFF	OFF
5	ON	OFF	ON	OFF	OFF	OFF	OFF	OFF
6	OFF	ON	ON	OFF	OFF	OFF	OFF	OFF
7	ON	ON	ON	OFF	OFF	OFF	OFF	OFF
8	OFF	OFF	OFF	ON	OFF	OFF	OFF	OFF
9	ON	OFF	OFF	ON	OFF	OFF	OFF	OFF
10	OFF	ON	OFF	ON	OFF	OFF	OFF	OFF
11	ON	ON	OFF	ON	OFF	OFF	OFF	OFF
12	OFF	OFF	ON	ON	OFF	OFF	OFF	OFF
13	ON	OFF	ON	ON	OFF	OFF	OFF	OFF
14	OFF	ON	ON	ON	OFF	OFF	OFF	OFF
15	ON	ON	ON	ON	OFF	OFF	OFF	OFF
16	OFF	OFF	OFF	OFF	ON	OFF	OFF	OFF
17	ON	OFF	OFF	OFF	ON	OFF	OFF	OFF
18	OFF	ON	OFF	OFF	ON	OFF	OFF	OFF
19	ON	ON	OFF	OFF	ON	OFF	OFF	OFF
20	OFF	OFF	ON	OFF	ON	OFF	OFF	OFF
21	ON	OFF	ON	OFF	ON	OFF	OFF	OFF
22	OFF	ON	ON	OFF	ON	OFF	OFF	OFF
23	ON	ON	ON	OFF	ON	OFF	OFF	OFF
24	OFF	OFF	OFF	ON	ON	OFF	OFF	OFF
25	ON	OFF	OFF	ON	ON	OFF	OFF	OFF
26	OFF	ON	OFF	ON	ON	OFF	OFF	OFF
27	ON	ON	OFF	ON	ON	OFF	OFF	OFF
28	OFF	OFF	ON	ON	ON	OFF	OFF	OFF
29	ON	OFF	ON	ON	ON	OFF	OFF	OFF
30	OFF	ON	ON	ON	ON	OFF	OFF	OFF
31	ON	ON	ON	ON	ON	OFF	OFF	OFF
32	OFF	OFF	OFF	OFF	OFF	ON	OFF	OFF
33	ON	OFF	OFF	OFF	OFF	ON	OFF	OFF
34	OFF	ON	OFF	OFF	OFF	ON	OFF	OFF
35	ON	ON	OFF	OFF	OFF	ON	OFF	OFF
36	OFF	OFF	ON	OFF	OFF	ON	OFF	OFF
37	ON	OFF	ON	OFF	OFF	ON	OFF	OFF

ID	SW1-#1	SW1-#2	SW1-#3	SW1-#4	SW1-#5	SW1-#6	SW1-#7	SW1-#8
38	OFF	ON	ON	OFF	OFF	ON	OFF	OFF
39	ON	ON	ON	OFF	OFF	ON	OFF	OFF
40	OFF	OFF	OFF	ON	OFF	ON	OFF	OFF
41	ON	OFF	OFF	ON	OFF	ON	OFF	OFF
42	OFF	ON	OFF	ON	OFF	ON	OFF	OFF
43	ON	ON	OFF	ON	OFF	ON	OFF	OFF
44	OFF	OFF	ON	ON	OFF	ON	OFF	OFF
45	ON	OFF	ON	ON	OFF	ON	OFF	OFF
46	OFF	ON	ON	ON	OFF	ON	OFF	OFF
47	ON	ON	ON	ON	OFF	ON	OFF	OFF
48	OFF	OFF	OFF	OFF	ON	ON	OFF	OFF
49	ON	OFF	OFF	OFF	ON	ON	OFF	OFF
50	OFF	ON	OFF	OFF	ON	ON	OFF	OFF
51	ON	ON	OFF	OFF	ON	ON	OFF	OFF
52	OFF	OFF	ON	OFF	ON	ON	OFF	OFF
53	ON	OFF	ON	OFF	ON	ON	OFF	OFF
54	OFF	ON	ON	OFF	ON	ON	OFF	OFF
55	ON	ON	ON	OFF	ON	ON	OFF	OFF
56	OFF	OFF	OFF	ON	ON	ON	OFF	OFF
57	ON	OFF	OFF	ON	ON	ON	OFF	OFF
58	OFF	ON	OFF	ON	ON	ON	OFF	OFF
59	ON	ON	OFF	ON	ON	ON	OFF	OFF
60	OFF	OFF	ON	ON	ON	ON	OFF	OFF
61	ON	OFF	ON	ON	ON	ON	OFF	OFF
62	OFF	ON	ON	ON	ON	ON	OFF	OFF
63	ON	ON	ON	ON	ON	ON	OFF	OFF
64	OFF	OFF	OFF	OFF	OFF	OFF	ON	OFF
65	ON	OFF	OFF	OFF	OFF	OFF	ON	OFF
66	OFF	ON	OFF	OFF	OFF	OFF	ON	OFF
67	ON	ON	OFF	OFF	OFF	OFF	ON	OFF
68	OFF	OFF	ON	OFF	OFF	OFF	ON	OFF
69	ON	OFF	ON	OFF	OFF	OFF	ON	OFF
70	OFF	ON	ON	OFF	OFF	OFF	ON	OFF
71	ON	ON	ON	OFF	OFF	OFF	ON	OFF
72	OFF	OFF	OFF	ON	OFF	OFF	ON	OFF
73	ON	OFF	OFF	ON	OFF	OFF	ON	OFF
74	OFF	ON	OFF	ON	OFF	OFF	ON	OFF
75	ON	ON	OFF	ON	OFF	OFF	ON	OFF
76	OFF	OFF	ON	ON	OFF	OFF	ON	OFF

# connection & installation

---

ID	SW1-#1	SW1-#2	SW1-#3	SW1-#4	SW1-#5	SW1-#6	SW1-#7	SW1-#8
77	ON	OFF	ON	ON	OFF	OFF	ON	OFF
78	OFF	ON	ON	ON	OFF	OFF	ON	OFF
79	ON	ON	ON	ON	OFF	OFF	ON	OFF
80	OFF	OFF	OFF	OFF	ON	OFF	ON	OFF
81	ON	OFF	OFF	OFF	ON	OFF	ON	OFF
82	OFF	ON	OFF	OFF	ON	OFF	ON	OFF
83	ON	ON	OFF	OFF	ON	OFF	ON	OFF
84	OFF	OFF	ON	OFF	ON	OFF	ON	OFF
85	ON	OFF	ON	OFF	ON	OFF	ON	OFF
86	OFF	ON	ON	OFF	ON	OFF	ON	OFF
87	ON	ON	ON	OFF	ON	OFF	ON	OFF
88	OFF	OFF	OFF	ON	ON	OFF	ON	OFF
89	ON	OFF	OFF	ON	ON	OFF	ON	OFF
90	OFF	ON	OFF	ON	ON	OFF	ON	OFF
91	ON	ON	OFF	ON	ON	OFF	ON	OFF
92	OFF	OFF	ON	ON	ON	OFF	ON	OFF
93	ON	OFF	ON	ON	ON	OFF	ON	OFF
94	OFF	ON	ON	ON	ON	OFF	ON	OFF
95	ON	ON	ON	ON	ON	OFF	ON	OFF
96	OFF	OFF	OFF	OFF	OFF	ON	ON	OFF
97	ON	OFF	OFF	OFF	OFF	ON	ON	OFF
98	OFF	ON	OFF	OFF	OFF	ON	ON	OFF
99	ON	ON	OFF	OFF	OFF	ON	ON	OFF
100	OFF	OFF	ON	OFF	OFF	ON	ON	OFF
101	ON	OFF	ON	OFF	OFF	ON	ON	OFF
102	OFF	ON	ON	OFF	OFF	ON	ON	OFF
103	ON	ON	ON	OFF	OFF	ON	ON	OFF
104	OFF	OFF	OFF	ON	OFF	ON	ON	OFF
105	ON	OFF	OFF	ON	OFF	ON	ON	OFF
106	OFF	ON	OFF	ON	OFF	ON	ON	OFF
107	ON	ON	OFF	ON	OFF	ON	ON	OFF
108	OFF	OFF	ON	ON	OFF	ON	ON	OFF
109	ON	OFF	ON	ON	OFF	ON	ON	OFF
110	OFF	ON	ON	ON	OFF	ON	ON	OFF
111	ON	ON	ON	ON	OFF	ON	ON	OFF
112	OFF	OFF	OFF	OFF	ON	ON	ON	OFF
113	ON	OFF	OFF	OFF	ON	ON	ON	OFF
114	OFF	ON	OFF	OFF	ON	ON	ON	OFF
115	ON	ON	OFF	OFF	ON	ON	ON	OFF

ID	SW1-#1	SW1-#2	SW1-#3	SW1-#4	SW1-#5	SW1-#6	SW1-#7	SW1-#8
116	OFF	OFF	ON	OFF	ON	ON	ON	OFF
117	ON	OFF	ON	OFF	ON	ON	ON	OFF
118	OFF	ON	ON	OFF	ON	ON	ON	OFF
119	ON	ON	ON	OFF	ON	ON	ON	OFF
120	OFF	OFF	OFF	ON	ON	ON	ON	OFF
121	ON	OFF	OFF	ON	ON	ON	ON	OFF
122	OFF	ON	OFF	ON	ON	ON	ON	OFF
123	ON	ON	OFF	ON	ON	ON	ON	OFF
124	OFF	OFF	ON	ON	ON	ON	ON	OFF
125	ON	OFF	ON	ON	ON	ON	ON	OFF
126	OFF	ON	ON	ON	ON	ON	ON	OFF
127	ON	ON	ON	ON	ON	ON	ON	OFF
128	OFF	OFF	OFF	OFF	OFF	OFF	OFF	ON
129	ON	OFF	OFF	OFF	OFF	OFF	OFF	ON
130	OFF	ON	OFF	OFF	OFF	OFF	OFF	ON
131	ON	ON	OFF	OFF	OFF	OFF	OFF	ON
132	OFF	OFF	ON	OFF	OFF	OFF	OFF	ON
133	ON	OFF	ON	OFF	OFF	OFF	OFF	ON
134	OFF	ON	ON	OFF	OFF	OFF	OFF	ON
135	ON	ON	ON	OFF	OFF	OFF	OFF	ON
136	OFF	OFF	OFF	ON	OFF	OFF	OFF	ON
137	ON	OFF	OFF	ON	OFF	OFF	OFF	ON
138	OFF	ON	OFF	ON	OFF	OFF	OFF	ON
139	ON	ON	OFF	ON	OFF	OFF	OFF	ON
140	OFF	OFF	ON	ON	OFF	OFF	OFF	ON
141	ON	OFF	ON	ON	OFF	OFF	OFF	ON
142	OFF	ON	ON	ON	OFF	OFF	OFF	ON
143	ON	ON	ON	ON	OFF	OFF	OFF	ON
144	OFF	OFF	OFF	OFF	ON	OFF	OFF	ON
145	ON	OFF	OFF	OFF	ON	OFF	OFF	ON
146	OFF	ON	OFF	OFF	ON	OFF	OFF	ON
147	ON	ON	OFF	OFF	ON	OFF	OFF	ON
148	OFF	OFF	ON	OFF	ON	OFF	OFF	ON
149	ON	OFF	ON	OFF	ON	OFF	OFF	ON
150	OFF	ON	ON	OFF	ON	OFF	OFF	ON
151	ON	ON	ON	OFF	ON	OFF	OFF	ON
152	OFF	OFF	OFF	ON	ON	OFF	OFF	ON
153	ON	OFF	OFF	ON	ON	OFF	OFF	ON
154	OFF	ON	OFF	ON	ON	OFF	OFF	ON

# connection & installation

---

ID	SW1-#1	SW1-#2	SW1-#3	SW1-#4	SW1-#5	SW1-#6	SW1-#7	SW1-#8
155	ON	ON	OFF	ON	ON	OFF	OFF	ON
156	OFF	OFF	ON	ON	ON	OFF	OFF	ON
157	ON	OFF	ON	ON	ON	OFF	OFF	ON
158	OFF	ON	ON	ON	ON	OFF	OFF	ON
159	ON	ON	ON	ON	ON	OFF	OFF	ON
160	OFF	OFF	OFF	OFF	OFF	ON	OFF	ON
161	ON	OFF	OFF	OFF	OFF	ON	OFF	ON
162	OFF	ON	OFF	OFF	OFF	ON	OFF	ON
163	ON	ON	OFF	OFF	OFF	ON	OFF	ON
164	OFF	OFF	ON	OFF	OFF	ON	OFF	ON
165	ON	OFF	ON	OFF	OFF	ON	OFF	ON
166	OFF	ON	ON	OFF	OFF	ON	OFF	ON
167	ON	ON	ON	OFF	OFF	ON	OFF	ON
168	OFF	OFF	OFF	ON	OFF	ON	OFF	ON
169	ON	OFF	OFF	ON	OFF	ON	OFF	ON
170	OFF	ON	OFF	ON	OFF	ON	OFF	ON
171	ON	ON	OFF	ON	OFF	ON	OFF	ON
172	OFF	OFF	ON	ON	OFF	ON	OFF	ON
173	ON	OFF	ON	ON	OFF	ON	OFF	ON
174	OFF	ON	ON	ON	OFF	ON	OFF	ON
175	ON	ON	ON	ON	OFF	ON	OFF	ON
176	OFF	OFF	OFF	OFF	ON	ON	OFF	ON
177	ON	OFF	OFF	OFF	ON	ON	OFF	ON
178	OFF	ON	OFF	OFF	ON	ON	OFF	ON
179	ON	ON	OFF	OFF	ON	ON	OFF	ON
180	OFF	OFF	ON	OFF	ON	ON	OFF	ON
181	ON	OFF	ON	OFF	ON	ON	OFF	ON
182	OFF	ON	ON	OFF	ON	ON	OFF	ON
183	ON	ON	ON	OFF	ON	ON	OFF	ON
184	OFF	OFF	OFF	ON	ON	ON	OFF	ON
185	ON	OFF	OFF	ON	ON	ON	OFF	ON
186	OFF	ON	OFF	ON	ON	ON	OFF	ON
187	ON	ON	OFF	ON	ON	ON	OFF	ON
188	OFF	OFF	ON	ON	ON	ON	OFF	ON
189	ON	OFF	ON	ON	ON	ON	OFF	ON
190	OFF	ON	ON	ON	ON	ON	OFF	ON
191	ON	ON	ON	ON	ON	ON	OFF	ON
192	OFF	OFF	OFF	OFF	OFF	OFF	ON	ON
193	ON	OFF	OFF	OFF	OFF	OFF	ON	ON



ID	SW1-#1	SW1-#2	SW1-#3	SW1-#4	SW1-#5	SW1-#6	SW1-#7	SW1-#8
194	OFF	ON	OFF	OFF	OFF	OFF	ON	ON
195	ON	ON	OFF	OFF	OFF	OFF	ON	ON
196	OFF	OFF	ON	OFF	OFF	OFF	ON	ON
197	ON	OFF	ON	OFF	OFF	OFF	ON	ON
198	OFF	ON	ON	OFF	OFF	OFF	ON	ON
199	ON	ON	ON	OFF	OFF	OFF	ON	ON
200	OFF	OFF	OFF	ON	OFF	OFF	ON	ON
201	ON	OFF	OFF	ON	OFF	OFF	ON	ON
202	OFF	ON	OFF	ON	OFF	OFF	ON	ON
203	ON	ON	OFF	ON	OFF	OFF	ON	ON
204	OFF	OFF	ON	ON	OFF	OFF	ON	ON
205	ON	OFF	ON	ON	OFF	OFF	ON	ON
206	OFF	ON	ON	ON	OFF	OFF	ON	ON
207	ON	ON	ON	ON	OFF	OFF	ON	ON
208	OFF	OFF	OFF	OFF	ON	OFF	ON	ON
209	ON	OFF	OFF	OFF	ON	OFF	ON	ON
210	OFF	ON	OFF	OFF	ON	OFF	ON	ON
211	ON	ON	OFF	OFF	ON	OFF	ON	ON
212	OFF	OFF	ON	OFF	ON	OFF	ON	ON
213	ON	OFF	ON	OFF	ON	OFF	ON	ON
214	OFF	ON	ON	OFF	ON	OFF	ON	ON
215	ON	ON	ON	OFF	ON	OFF	ON	ON
216	OFF	OFF	OFF	ON	ON	OFF	ON	ON
217	ON	OFF	OFF	ON	ON	OFF	ON	ON
218	OFF	ON	OFF	ON	ON	OFF	ON	ON
219	ON	ON	OFF	ON	ON	OFF	ON	ON
220	OFF	OFF	ON	ON	ON	OFF	ON	ON
221	ON	OFF	ON	ON	ON	OFF	ON	ON
222	OFF	ON	ON	ON	ON	OFF	ON	ON
223	ON	ON	ON	ON	ON	OFF	ON	ON
224	OFF	OFF	OFF	OFF	OFF	ON	ON	ON
225	ON	OFF	OFF	OFF	OFF	ON	ON	ON
226	OFF	ON	OFF	OFF	OFF	ON	ON	ON
227	ON	ON	OFF	OFF	OFF	ON	ON	ON
228	OFF	OFF	ON	OFF	OFF	ON	ON	ON
229	ON	OFF	ON	OFF	OFF	ON	ON	ON
230	OFF	ON	ON	OFF	OFF	ON	ON	ON
231	ON	ON	ON	OFF	OFF	ON	ON	ON
232	OFF	OFF	OFF	ON	OFF	ON	ON	ON

# connection & installation

---

ID	SW1-#1	SW1-#2	SW1-#3	SW1-#4	SW1-#5	SW1-#6	SW1-#7	SW1-#8
233	ON	OFF	OFF	ON	OFF	ON	ON	ON
234	OFF	ON	OFF	ON	OFF	ON	ON	ON
235	ON	ON	OFF	ON	OFF	ON	ON	ON
236	OFF	OFF	ON	ON	OFF	ON	ON	ON
237	ON	OFF	ON	ON	OFF	ON	ON	ON
238	OFF	ON	ON	ON	OFF	ON	ON	ON
239	ON	ON	ON	ON	OFF	ON	ON	ON
240	OFF	OFF	OFF	OFF	ON	ON	ON	ON
241	ON	OFF	OFF	OFF	ON	ON	ON	ON
242	OFF	ON	OFF	OFF	ON	ON	ON	ON
243	ON	ON	OFF	OFF	ON	ON	ON	ON
244	OFF	OFF	ON	OFF	ON	ON	ON	ON
245	ON	OFF	ON	OFF	ON	ON	ON	ON
246	OFF	ON	ON	OFF	ON	ON	ON	ON
247	ON	ON	ON	OFF	ON	ON	ON	ON
248	OFF	OFF	OFF	ON	ON	ON	ON	ON
249	ON	OFF	OFF	ON	ON	ON	ON	ON
250	OFF	ON	OFF	ON	ON	ON	ON	ON
251	ON	ON	OFF	ON	ON	ON	ON	ON
252	OFF	OFF	ON	ON	ON	ON	ON	ON
253	ON	OFF	ON	ON	ON	ON	ON	ON
254	OFF	ON	ON	ON	ON	ON	ON	ON
255	ON	ON	ON	ON	ON	ON	ON	ON

## PREPARING ADAPTER AND CABLES

### ● Power Adapter

Power adapter has the capacity of AC24V 2.5A(HCP-6320) / AC24V 3A.(HCP-6320H)

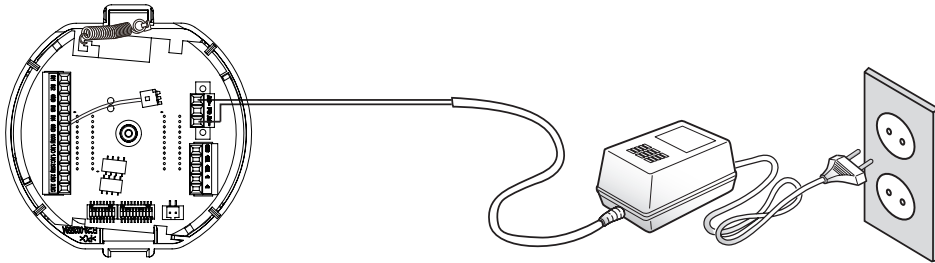

<Camera Wiring Interface Board>



- After connecting the power cable by separating the power connector from the terminal, make the connection between terminal and connector by using a bolt.

### ● Video Cable

The camera's video output port is connected to the monitor with a BNC coaxial cable, shown below :  
If the distance between the camera and the monitor exceeds the recommended maximum, please use an auxiliary video amp.

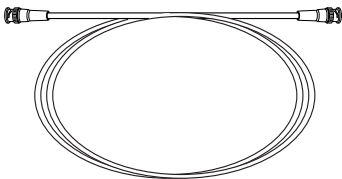

Distance	Recommended Cable Specification
300m	3C2V
500m	5C2V

### ● Communications Cable

For the camera to communicate with the controller, a RS-485/422 communications line is required. To ensure the quality of long distance communication and the accuracy of the overall communication it is recommended using a twisted pair cable such as UTP.

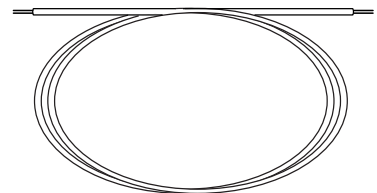

- Depending on the camera's environment, the communications distance may vary.
- Neither the video nor communications cable is enclosed with the camera.

# connection & installation

## PRODUCT CONFIGURATIONS

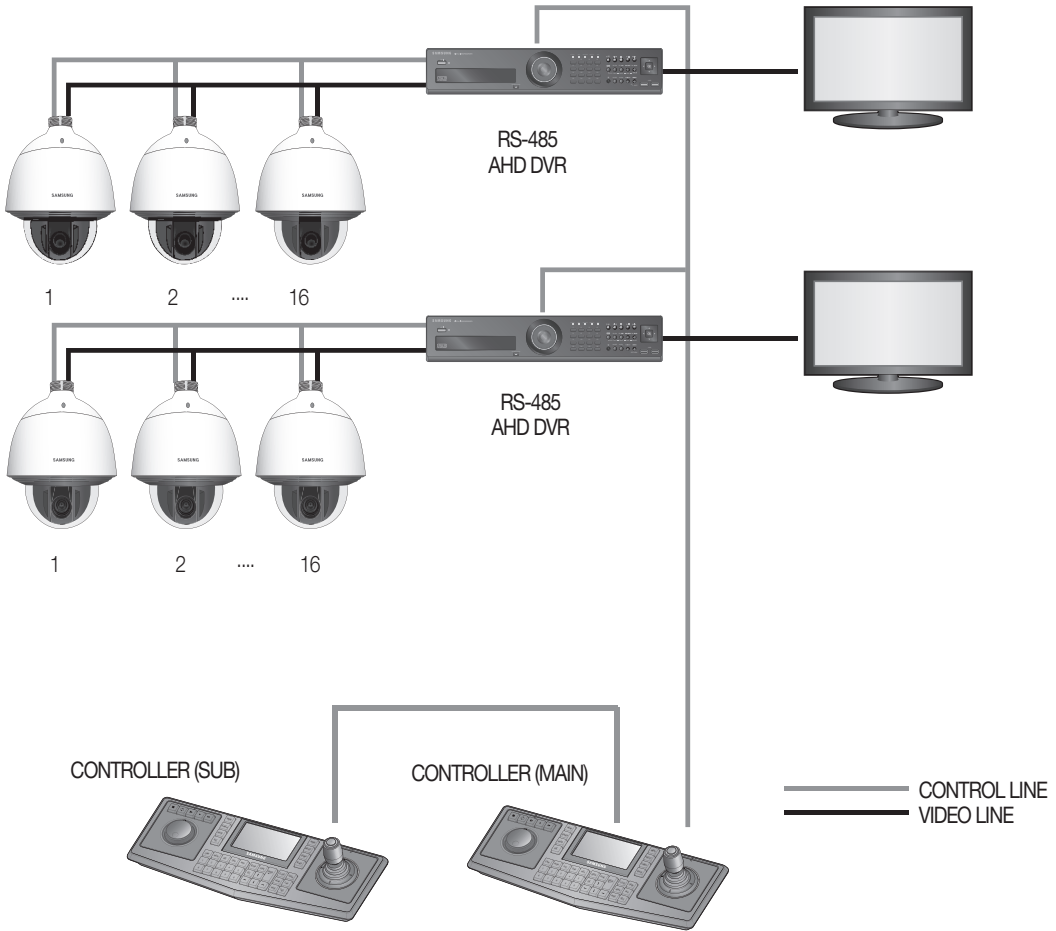

## PREPARING & INSTALLING CAMERA BRACKET

For installation guidelines for brackets and housings, refer to the installation manual that is enclosed with the bracket or housing.

### ❖ Available Bracket Models

Model	Item	Indoor Model	Environmental Model	
SHP-3701H	Outdoor Housing	Yes	-	
SHP-3701F	In-ceiling Housing			
SBP-300HM3	Hanging Mount			
SBP-300WM1	Wall Mount		Yes	Yes
SBP-300WM				
SBP-300CM	Ceiling Mount			
SBP-300LM	Parapet Mount			
SBP-300KM	Corner Mount			
SBP-300PM	Pole Mount			



- See "Optional Accessories for Installation" for the appearance of each bracket

# connection & installation

---

## OPTIONAL ACCESSORIES FOR INSTALLATION

---

For your easier installation, you can purchase appropriate optional accessories available.

**1. If installing the camera on the wall**

- Wall mount (SBP-300WM1)

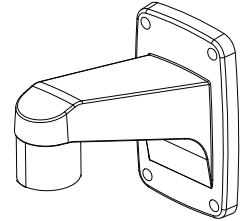

- Wall mount (SBP-300WM)

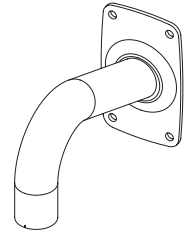

**2. If installing the camera on the ceiling**

- Ceiling Mount (SBP-300CM)

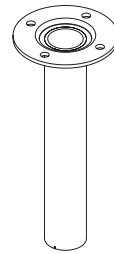

**3. If installing the wall mount (SBP-300WM/SBP-300WM1) on an at least 80mm-long cylinder**

- Pole Mount (SBP-300PM)

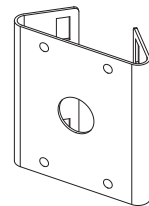

- 4. If installing the wall mount (SBP-300WM/SBP-300WM1) on a corner of the wall
  - Corner Mount (SBP-300KM)

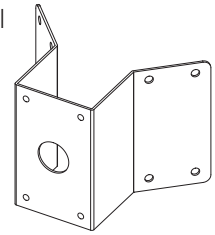

- 5. If installing on a building rooftop
  - Parapet Mount (SBP-300LM)

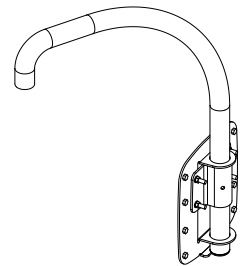

- 6. If installing an indoor model outdoors
  - Outdoor Housing (SHP-3701H)

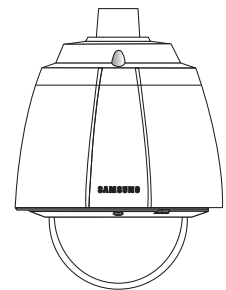

- 7. If installing an indoor model on the ceiling
  - Flush-Mount Indoor Housing for PTZ Dome Camera (SHP-3701F)

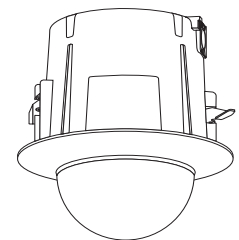

- 8. If installing an indoor model on the wall mount or ceiling mount
  - Hanging Mount (SBP-300HM3)

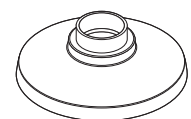

# connection & installation

---

- Bracket Mounting (Indoor Model)

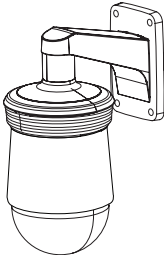

Wall mount (SBP-300WM1, SBP-300HM3)

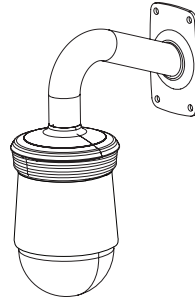

Wall mount (SBP-300WM, SBP-300HM3)

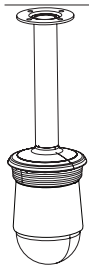

Ceiling Mount (SBP-300CM, SBP-300HM3)

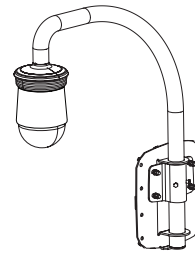

Parapet Mount (SBP-300LM, SBP-300HM3)

- Bracket Mounting (Environmental Model)

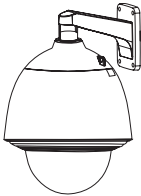

Wall mount (SBP-300WM1)

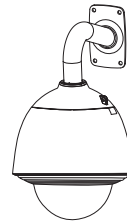

Wall mount (SBP-300WM)

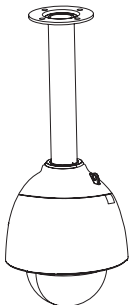

Ceiling Mount (SBP-300CM)

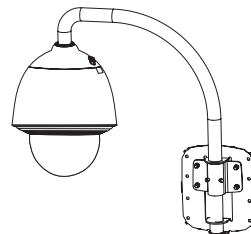

Parapet Mount (SBP-300LM)



## ON-CEILING MOUNT TYPE INSTALLATION EXAMPLE

### ● Attaching the template and installing the install base

1. Attach the provided template on the ceiling. Based on the template, drill a 86mm hole in the ceiling and arrange the wires through the hole.
2. Install installation base as shown.
3. Before installing the exposed bracket, open the hinged door at the bottom of the bracket as shown in the picture. Hold the knob on the hinged door to open it.



- In the case of installing the camera at highly humid place, install it on the ceiling after attaching the enclosed insulation sheet on the back of install base.

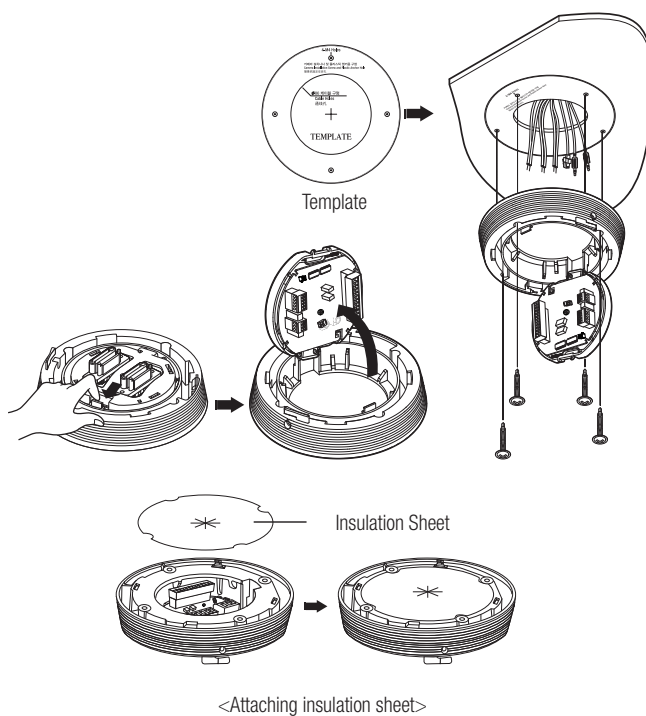

### ● Wiring Terminal Cables

1. Connect the cables to the terminal block on the hinged door. Refer to “**Camera Wiring Interface Board**”. (page 16)
2. Once the wiring is complete, close the hinged door.



- Do not connect the camera to a power outlet until the installation is complete. Supplying power while the installation is in progress may cause fire or damage the product.

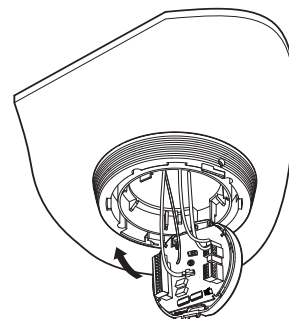

# connection & installation

## • Setting Up Camera DIP Switches

DIP switches for communication and ID protocols are located on the bottom of the install base. For the switch settings, refer to the dip switch settings of this manual.

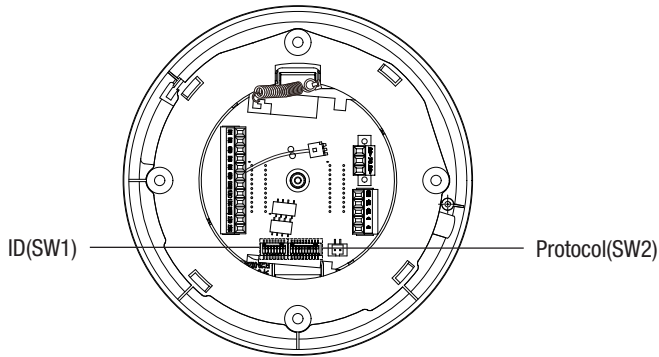

## • Connecting Camera Safety Cable and Attaching Camera

1. First, as shown in the left hand picture, pull out the safety cable from the base and then hook it to the mount. The safety cable is coiled inside the base.
  - To attach the camera to the mount, refer to the alignment guide marks as shown in the picture.
2. Carefully attach the camera to the mount following the alignment guide marks as shown in the picture.

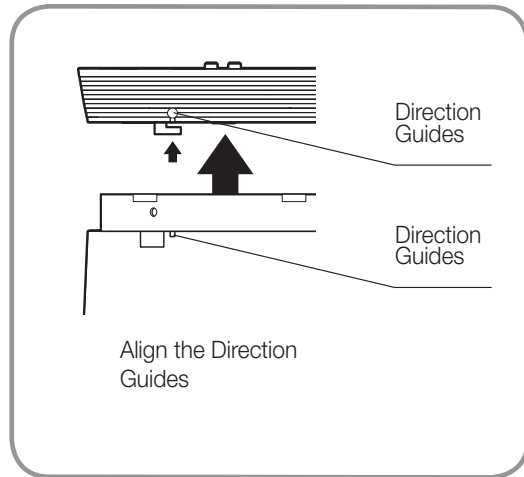
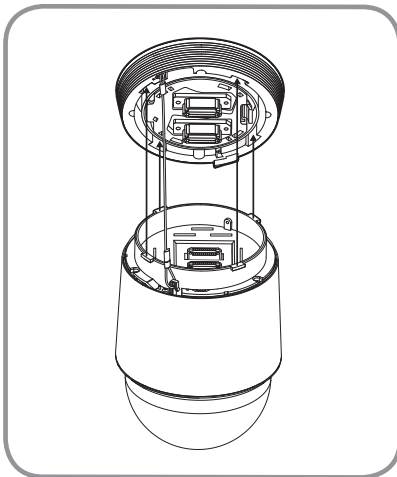

- Make sure to hook the camera's safety cable to the mount before proceeding. Otherwise you may be exposed to serious injury caused by the camera falling.

\* To attach or detach the camera, refer to the picture.

\* Attaching the Camera : Push up the camera unit and rotate it clockwise until it cannot be rotated anymore, as shown in the figure. After rotation, fasten the screws assembled to the install base.

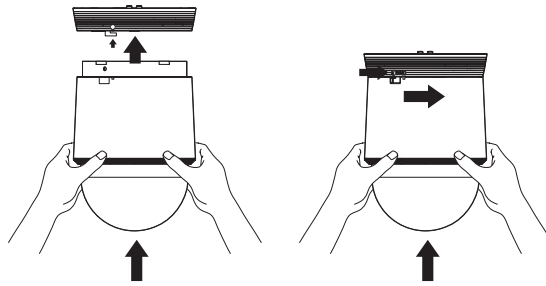

<To Attach the Camera>

\* Detaching the Camera : Unfasten the screws as shown in the figure, push in the hook, and rotate it counterclockwise.

(The screws are not completely disassembled.)

When the hook does not rotate any more, pull down the camera unit and separate it.

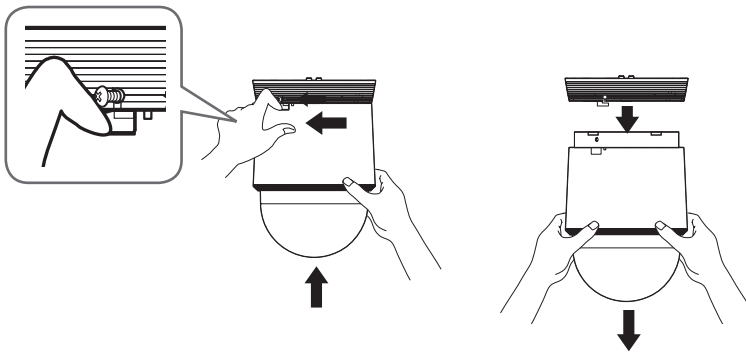

<To Detach the Camera>

# connection & installation

## EXAMPLE OF INSTALLING AN ENVIRONMENTAL MODEL

### ❖ Fix the installation base with the bracket

1. Fix the base with the bracket by turning it clockwise.

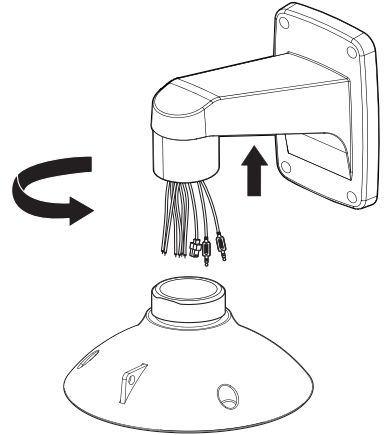

2. As shown in the picture below, gently press and lift up the handle of the hinged door on the bottom of the installation base. Please refer to the **“Camera Wiring Interface Board”** on page 16, connect the wires.

- Do not connect the camera to a power outlet until the installation is complete. Supplying power while the installation is in progress may cause fire or damage the product.

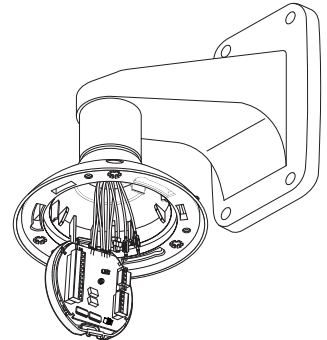

3. Connect the camera safety wire to the installation base.

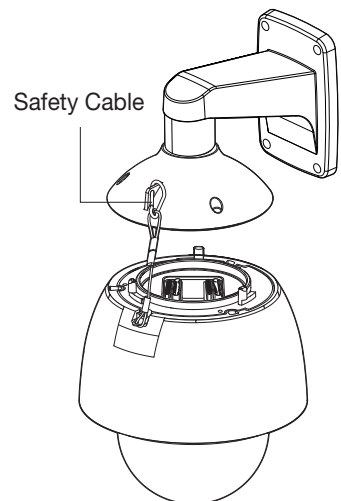

- 4. Assemble Camera and Installation Base  
Assemble the installation base and camera by matching the installation direction guides.

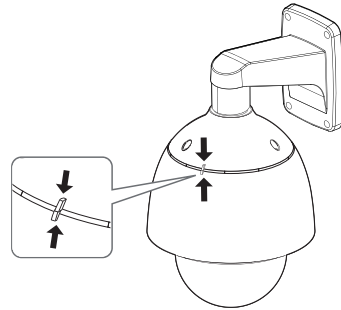

- 5. Attach Camera  
Rotate the mounted camera unit clockwise so that the reference indicators of top and bottom are as shown in the image on the right.

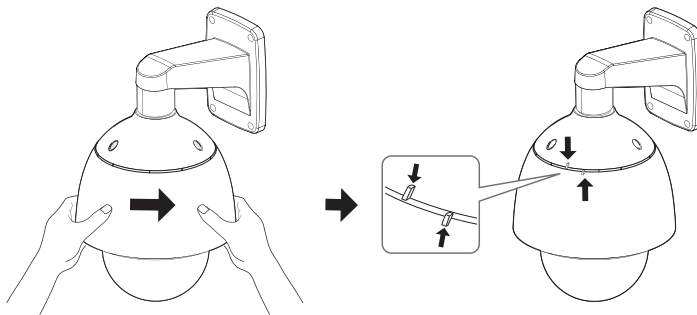

- 6. Secure Camera and Installation Base  
As shown in the picture below, secure the installation base and camera using 3 hexagon screws.

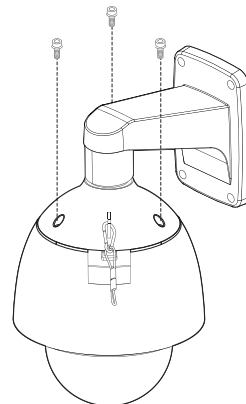

# connection & installation

## ❖ Notes for Waterproofing

This product is an indoor unit. If it is installed outdoors, use the outdoor housing to make it waterproof.

### ▪ Installing the unit on the wall by combining the outdoor housing and wall mount

1. Install the wall mount on the vertical wall. If the mount is installed on an inclined wall, moisture can penetrate inside the outdoor housing through the external cable.
2. Wrap the screw part of the housing with a sufficient amount of Teflon tape for assembly.
3. When separating the dome cover and fastening it to the housing frame, make sure that the gasket is not loosened to separate from the dome cover.
4. Install the wall mount adapter for waterproofing, and apply the silicon sealant between and around the wall and wall mount for sealing.

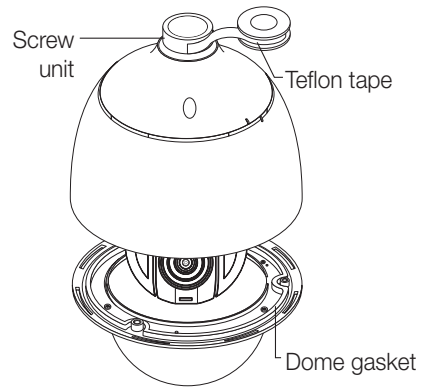
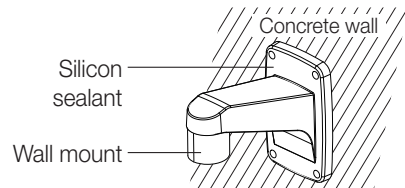

- Take particular caution to ensure that there is proper sealing if the installed side is not flat.

■ Installing on the wall by combining the outdoor housing and ceiling mount adapter

1. Wrap the screw part of the housing with a sufficient amount of Teflon tape for assembly.
2. When separating the dome cover and fastening it to the housing frame, make sure that the gasket is not loosened to separate from the dome cover.
3. Install the ceiling mount adapter for waterproofing, and apply the silicon sealant between and around the wall and ceiling mount for sealing.

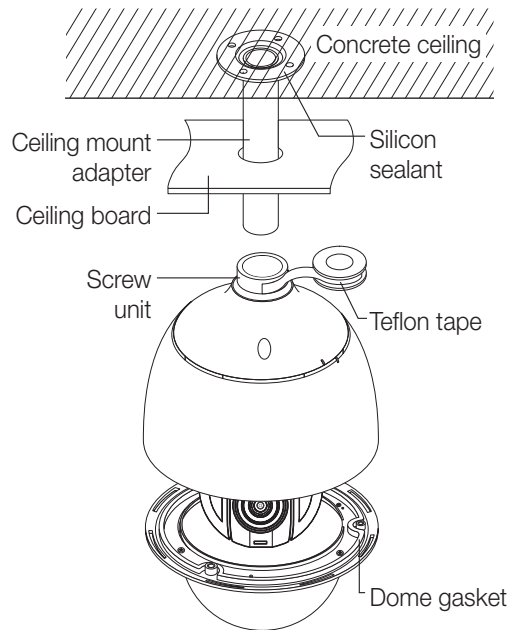

- Take particular caution to ensure that there is proper sealing if the installed side is not flat.

## INTERFACE SYMBOLS

- **Intelligence Standby/Operation Display :**

When in standby mode, the “**D**”, “**T**”, “**F**” in the upper of the screen changes to “” if motion is detected.

- **Alarm Input Port Status Display :**

“1”, “2”, “3” and “4” in the upper of the screen

- **Current Alarm Port Display According to Input Alarm Ports(Priority) :**

Only one of “1”, “2”, “3” and “4” in the upper of the screen.

- **Preset Number Display Settings :**

\* : If a preset number is already available

'H' : If a preset location is the camera's home position

- **PTZ Function Screen :**

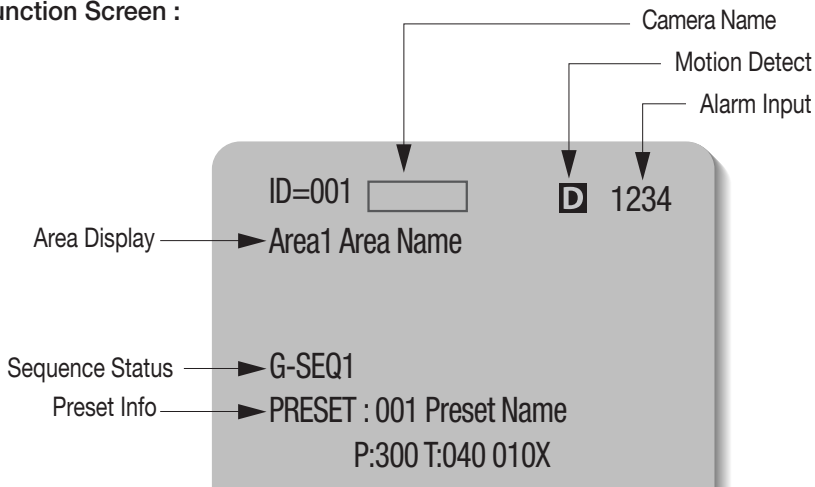

- **Preset Number Setting Screen :**

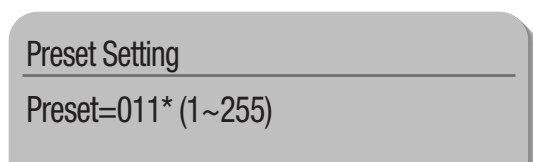



## USING AND SETTING THE MENUS

### OSD (On-screen Display) Indicators

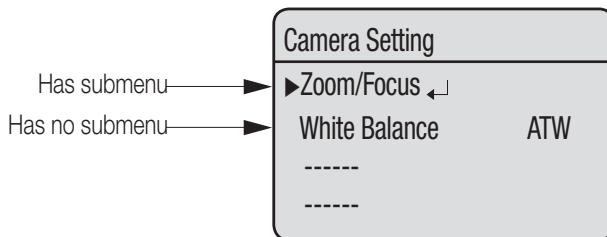

※ For a mode with “ $\leftarrow\downarrow$ ” next to it, you can press “Enter” to move to a sub menu.

### Operating Your Camera

- **Panning and Tilting :**

Use the joystick of the controller or its direction buttons.

- **Controlling Zoom :**

Move the joystick clockwise (Tele) or counterclockwise (Wide), or use the zoom buttons.

- **Accessing Screen Menus:**

Press the Menu or OSD button on the controller.



■ For more detailed information about controls using a third party controller or a DVR, refer to the user's manual of the product.

### OSD Commands, Function Chart, and Menu Controls (Applied to Samsung -T/Samsung-E protocol)

This camera can be operated using two methods: Using hot keys on its dedicated controller, or accessing the OSD (On Screen Display) on the video output.

The OSD menu commands are as follows:

Command	Function
Move the joystick up/down/left/right	Moves the OSD menus up/down/left/right, respectively.
Enter/Focus Far	Selects a menu and allows access to the sub menu.
ESC/Focus Near	Cancels a command and moves back to an upper-level menu.

## OSD Menu Chart

You can have an overall view of the menu structure. For more information, refer to the applicable page or section in the manual.

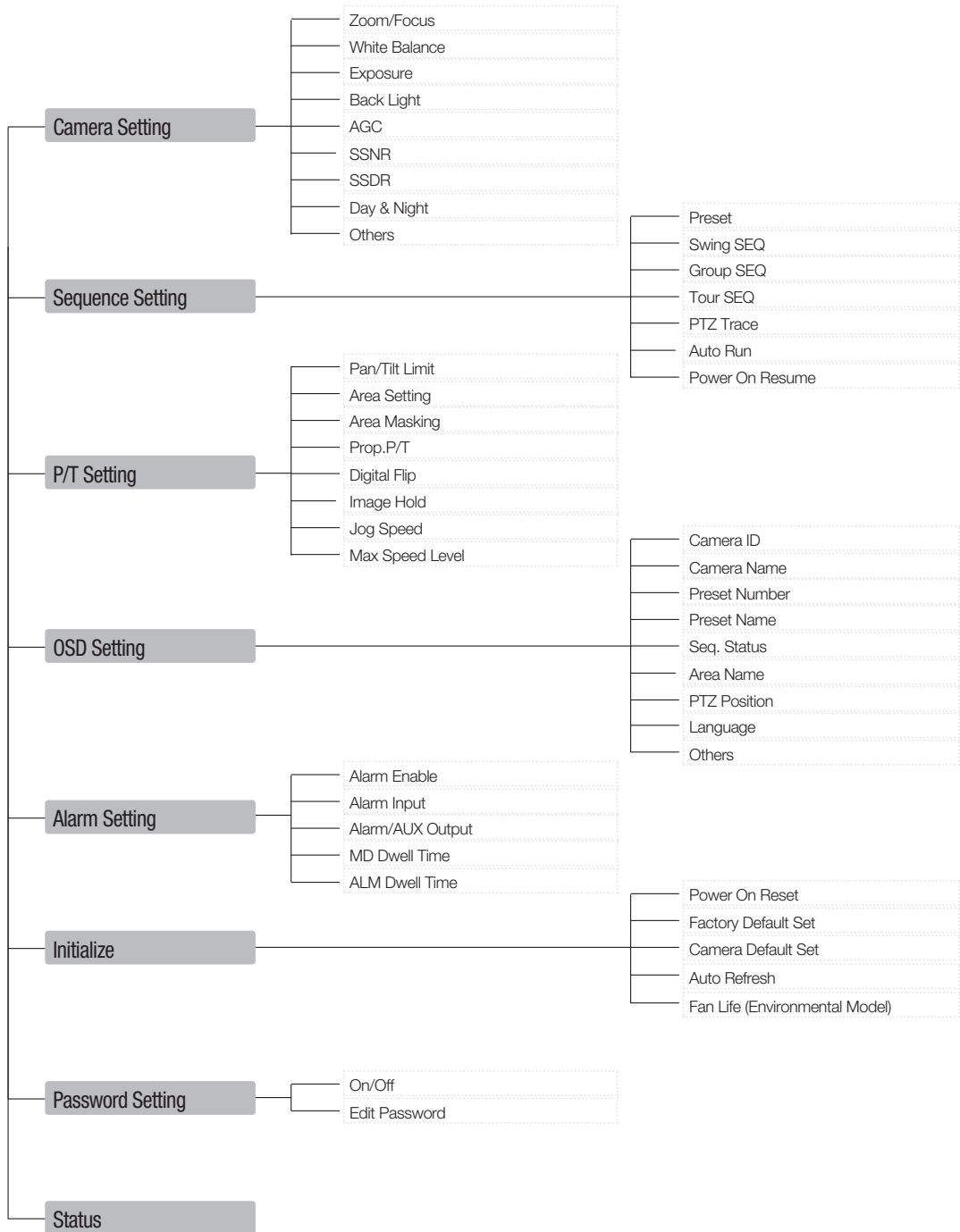

# CAMERA SETUP

## Zoom and Focus Settings

### ● Focus Mode

- AUTO : Performs continuous auto-focus.
- MANUAL : Changes the camera mode to Manual Focus.
- ONE SHOT : Auto-focuses the camera once after the Pan, Tilt, or Zoom function is used.

### ● Zoom Tracking

Through this menu you can set up the camera's focus mode when zooming.

- Mode
  - AUTO : Auto-focuses when zooming.
  - TRACKING : Focuses manually when zooming.
  - OFF : Disable the focus modes when zooming. (Full manual mode)
- Speed
  - SLOW/MEDIUM/FAST : Adjusts the zooming speed.

### ● Digital Zoom

Enables the maximum digital zoom.  
Setting the digital zoom to 16x provides a total zoom of 512x.



- Unlike the optical zoom, the graphics quality of the digital zoom decreases as its zoom ratio increases.
- The auto-focus function may not operate normally under the following conditions :
  - When background illumination is low
  - While Slow-Shutter is in operation
  - If the zoom level is set too high
  - When background illumination is too high
  - If a long distance object and a close distance object appear together within a monitoring area
  - If there is no contrast, e.g. the sky or a wall
  - If the camera is facing a thin horizontal line
- Auto Focus focuses on an object in the center of the screen; objects around the screen edges may not be properly in focus.

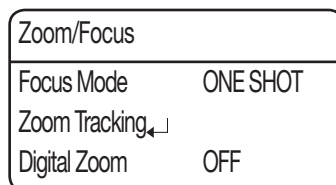
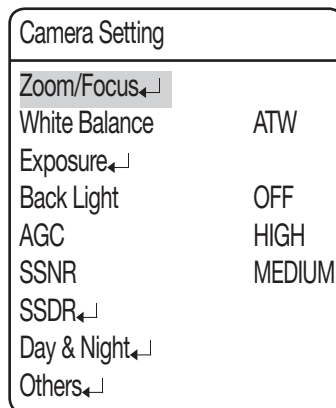
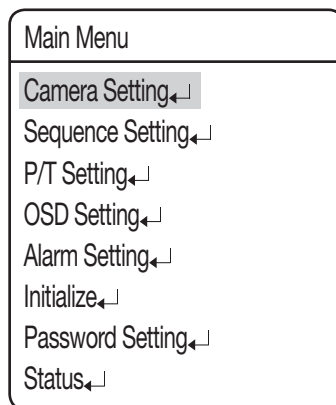

## White Balance

The White Balance menu adjusts the balance of the screen colors under different lighting conditions.

- **ATW** : Adjusts the screen color automatically.  
(Color Temperature:2400~10500°K)
- **ATW(IN)** : Adjusts the screen color to be optimal in an indoor environment. (Color Temperature:4500~8500°K)
- **ATW(OUT)** : Adjusts the screen color to be optimal in an outdoor environment. (Color Temperature:1700~11000°K)
- **AWC** : To obtain the optimal condition for the current lighting, put the focus of the camera to a white paper and press the SET button. If the lighting environment is changed, you should readjust the settings accordingly.
- **MANUAL** : Enables customization the Red and Blue gains.
- **MERCURY** : The image automatically compensates to the mercury lamp environment.
- **SODIUM** : The image automatically compensates to the sodium lamp environment.

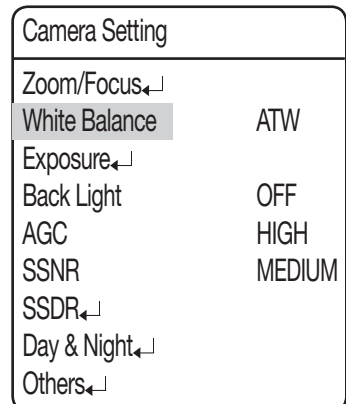
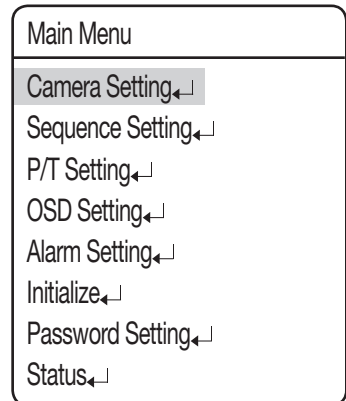

White Balance may not work properly under the following conditions.

- ① When the color temperature of the environment surrounding the subject is out of the control range.(e.g. Clear sky or sunset)
- ② When the ambient illumination of the subject is dim.
- ③ If the camera is directed towards a fluorescent light or is installed in a place where illumination changes dramatically, White Balance adjustments may not deliver consistent results.

## Exposure

The Exposure settings are to control the camera's exposure meter.

- **Brightness** : Adjusts the screen brightness.  
(Over 50: Brighter, Under 50: Darker)
- **Iris**
  - AUTO : Automatically adjusts the exposure meter.
  - MANUAL : Enables manual adjustment of the exposure meter.  
(F1.6~Close: 9 levels)
- **Shutter** : Controls the camera's electronic shutter.
  - --- : The shutter speed is fixed at 1/60 for NTSC and 1/50 for PAL. Operates when Iris is on the Auto Mode.
  - ESC : Adjusts the shutter speed automatically according to the screen brightness. Operates when Iris is on the Manual Mode.
  - A.FLK : Select this setting when you experience picture flickering. Flickering can happen when artificial lighting frequencies clash with camera frame rates.
  - MANUAL : Enables manual adjustment of the shutter speed.
- **Sens-Up**
  - AUTO : Automatically detects light levels and maintains a clear picture at night or under low-light conditions.
  - Sens-Up Limit : Adjusts to the maximum-powered zoom per frame.



- For optimal performance of the A.FLK mode, avoid using the mode in conjunction with Backlight.
- While the Internal Sync mode is in effect, setting the shutter to '---' and facing the camera directly to a bright light source may cause poor camera performance.
- Sens-Up is disabled when the shutter is in Manual or A. FLK mode.

Main Menu	
Camera Setting	↵
Sequence Setting	↵
P/T Setting	↵
OSD Setting	↵
Alarm Setting	↵
Initialize	↵
Password Setting	↵
Status	↵



Camera Setting	
Zoom/Focus	↵
White Balance	ATW
Exposure	↵
Back Light	OFF
AGC	HIGH
SSNR	MEDIUM
SDDR	↵
Day & Night	↵
Others	↵



Exposure	
Brightness	050
Iris	AUTO
Shutter	---
Sens-Up	AUTO

## Back Light

The Backlight function provides a sharp image of both object and background against a severe counter-light condition.

### ● Back Light Mode

- OFF : Disables the Backlight mode.
- WDR : Activates the Wide Dynamic Range mode.
- HLC : Activates the High Light Compensation mode.
- BLC : Activates a user defined backlight compensation mode.

Main Menu	
Camera Setting	←
Sequence Setting	←
P/T Setting	←
OSD Setting	←
Alarm Setting	←
Initialize	←
Password Setting	←
Status	←



Camera Setting	
Zoom/Focus	←
White Balance	ATW
Exposure	←
Back Light	OFF
AGC	HIGH
SSNR	MEDIUM
SSDR	←
Day & Night	←
Others	←

### ◆ WDR

When there are both bright and dark areas at the same time, this mode makes both areas distinctive.

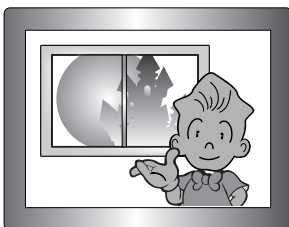

WDR ON

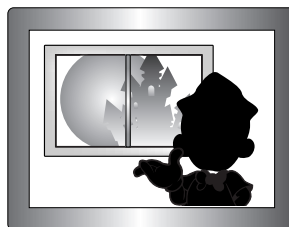

WDR OFF

WDR Setting	
Limit	MEDIUM

- Limit : Three WDR sensitivity levels are available in 3: Low, Medium , and High.

Note that the higher the sensitivity level, the lower the contrast in the light and dark areas becomes.

- 
  - During WDR ON/OFF switching, the image will be frozen for 3~5 seconds.
  - If you set both Iris and Shutter to "MANUAL", WDR will be disabled.
  - During WDR operation, noise, discoloration, spots, and whitish symptoms may occur depending on lighting conditions. If they occur, stop using WDR.

◆ **HLC Setting**

When a bright light enters a limited environment such as apartment parking lot entry or gas station entry, this function masks only the bright light so that items such as car license plate number can be monitored effectively.

HLC Setting	
Level	MEDIUM
Mask Tone	07

HLC is disabled during the daytime. While monitoring night time car traffic, if car headlights reflects too much bright light on the screen, the camera automatically eliminates the headlamp lights and adjusts the color of the license plate accordingly.

**HLC Masking Area**

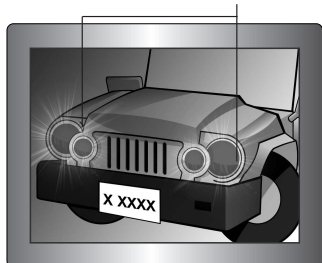

<HLC ON>



<HLC OFF>

- Level : Adjusts the HLC sensitivity level.
- Mask Tone : Adjusts the mask color on the high lighted area.

- 
  - Even if HLC is on, car license plates may not be detectable depending on the location and angle of the camera as well as the lighting condition.

## ◆ BLC Setting

You can selectively choose a screen area to see objects within the area more clearly than others.

- Four-direction Joystick Controls :  
Moving the joystick in all four directions—upward, downward, left, and right—adjusts the location and size of a selected area.
- Zoom Control :
  - Zoom Tele : Enlarges the size of a selected area.
  - Zoom Wide : Reduces the size of a selected area.

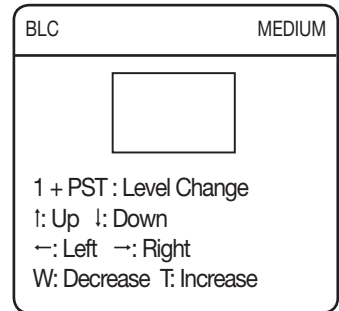

## AGC(Auto Gain Control)

AGC (Automatic Gain Control) adjusts the camera's gain control and the screen brightness if the camera has captured an object under low-light conditions.

- **OFF:**  
AGC does not function.
- **LOW/MEDIUM/HIGH:**  
As the level increases to HIGH, brighter the captured screen in a dark lighting.
- **MANUAL:**  
AGC can be fine tuned by adjusting the level (5dB ~ 41dB).

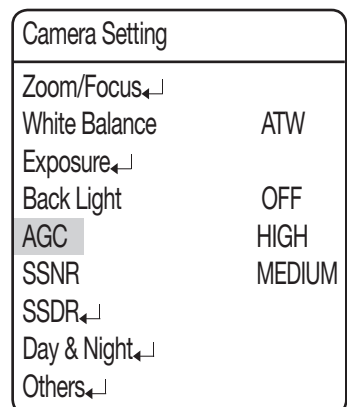
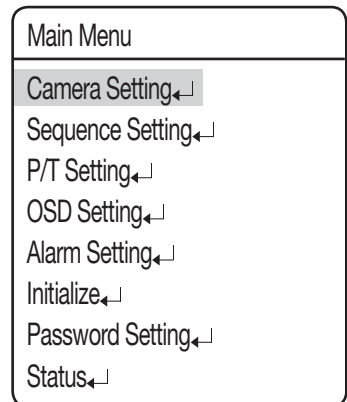



## SSNR(Samsung Super Noise Reduction)

SSNR significantly reduces the amount of low luminance noise.

- OFF : Disables the noise reduction function.
- LOW : Reduces only a small amount of noise, but generates almost no afterimage.
- MEDIUM : The most commonly used mode. Reduces a suitable amount of noise while generating a subtle afterimage.
- HIGH : Reduces noise significantly, but generates obvious afterimages.

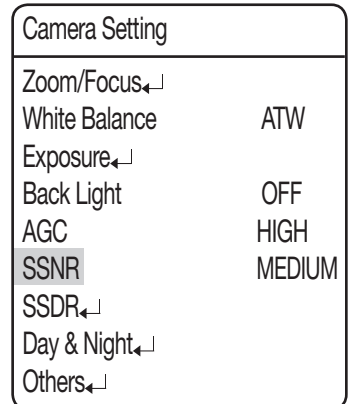
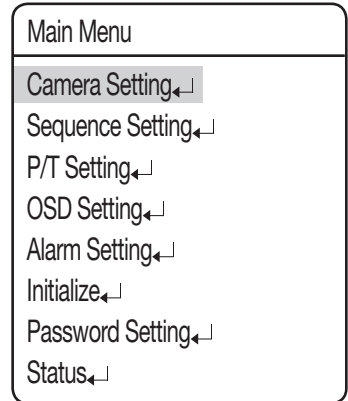

- SSNR is not available if AGC is set to OFF or MANUAL.

## SSDR(Samsung Super Dynamic Range)

SSDR illuminates darker spots of an image while retaining the same light level for brighter spots to even out the overall brightness of the image with high contrast between bright and dark spots.

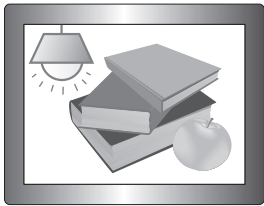

SSDR ON

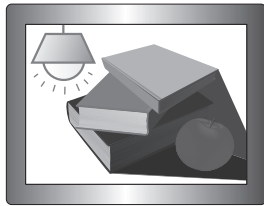

SSDR OFF

- Mode : Enables or disables SSDR.
- Level : Changes the contrast between bright and dark spots by the level.

Main Menu	
Camera Setting	←
Sequence Setting	←
P/T Setting	←
OSD Setting	←
Alarm Setting	←
Initialize	←
Password Setting	←
Status	←



Camera Setting	
Zoom/Focus	←
White Balance	ATW
Exposure	←
Back Light	OFF
AGC	HIGH
SSNR	MEDIUM
SSDR	←
Day & Night	←
Others	←



SSDR	
Mode	ON
Level	08

## Day & Night

The Day & Night function allows the camera to switch between the Color and B/W modes.

- **MODE**

- AUTO : Operates in Color mode most times, and switches to B/W mode if a low light level is detected during nighttime.
- COLOR : Operates in Color mode at all times.
- B/W : Operates in B/W mode at all times.

- **Duration :**

- The camera's ambient light diversion performance may vary depending on its environment.

- **Dwell Time :**

- The duration of both the lighting conditions can be customized to let the camera divert between the daytime and nighttime settings.



- Auto mode is not available if AGC is set to OFF or MANUAL. Only COLOR and B/W is available.
- Using B/W mode under sunlight or a halogen lamp may decrease the focusing performance.

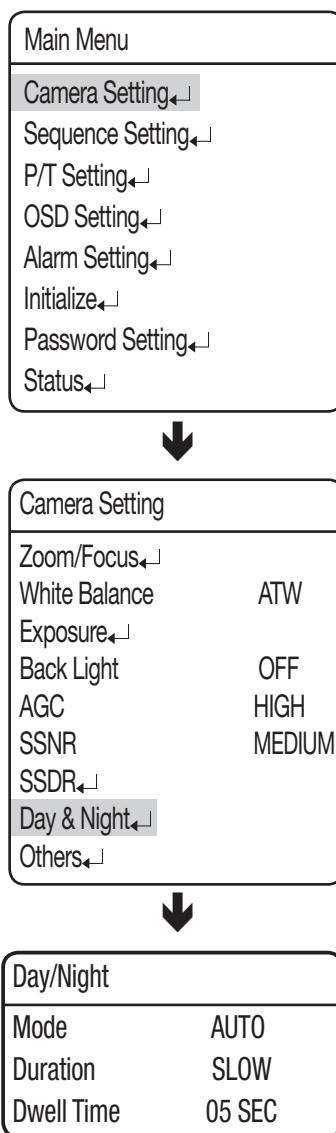

## Others

- **Defog** : You can improve images in foggy or cloudy weather.
  - Off : Fog removal function is not active.
  - Auto : Images are compensated automatically according to the amount of fog.
  - Manual : You can set the amount of compensation manually for the image.



- Use this function if the image is unclear due to foggy weather.
- If <Auto> is selected for the defog mode, the level is reduced as the fog is reduced.  
If you wish to maintain the fog removal level even when the amount of fog is reduced, select <Manual>.
- Note that the image can be dark if the fog level is high with the amount of fog being small.

- **Image Adj** :

- Sharpness : Sharpens outlines of an image.
- Color : Adjusts the color density of an image.

- **Freeze** : Stops or reanimates an image.
- **Stabilizer** : The Stabilizer compensates for any small movements of the camera caused by due to the wind and other reasonable causes



- The Stabilizer uses the digital zoom and may cause low picture quality.
- The Stabilizer is disabled if the ambient light is too low.
- The Stabilizer is disabled if the field of view has very low or no contrast, e.g. The sky or a white wall.

- **Dome Cover (Indoor Model)** :

The existence of the dome cover will minimize the quality difference according to the image formation position.

- OFF : If removing the dome cover before use
- ON : If using the product by factory default (using the dome cover)

Main Menu	
Camera Setting	↵
Sequence Setting	↵
P/T Setting	↵
OSD Setting	↵
Alarm Setting	↵
Initialize	↵
Password Setting	↵
Status	↵



Camera Setting	
Zoom/Focus	↵
White Balance	ATW
Exposure	↵
Back Light	OFF
AGC	HIGH
SSNR	MEDIUM
SDDR	↵
Day & Night	↵
Others	↵



Others	
Defog	OFF
Image Adj	↵
Freeze	OFF
Stabilizer	OFF
Dome Cover	ON

## Sequence Setting

### Preset

This function enables the memorization of a selected location and activates the Pan, Tilt, and Zoom functions at that location. Saved locations can be recalled using the Preset Execute command.

● **Setting Up Preset Numbers :**

Selecting the Preset Setting menu brings up a screen as shown below. Move the joystick in all four directions to select the desired number.

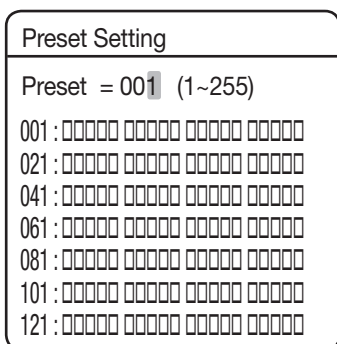

● **Saving Preset Locations :**

Selecting a preset number and pressing the Enter key redirects the menu to the screen shown below.

Using the joystick, adjust the location of the Pan and Tilt functions and then set the Zoom and Focus command.

In Preset mode, the zooming focus can be controlled only by the zoom command.

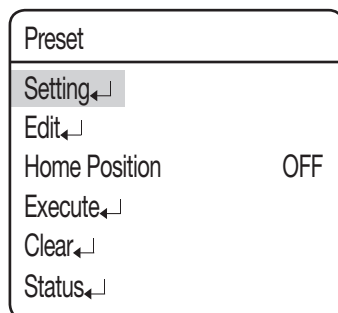
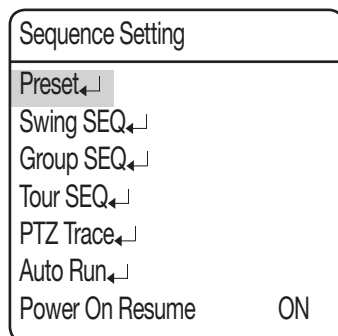
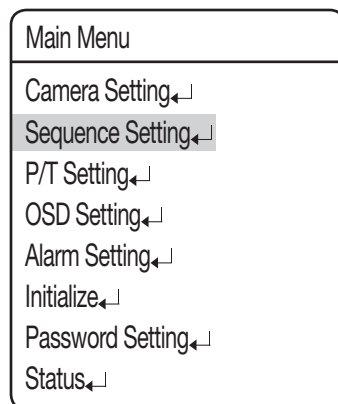
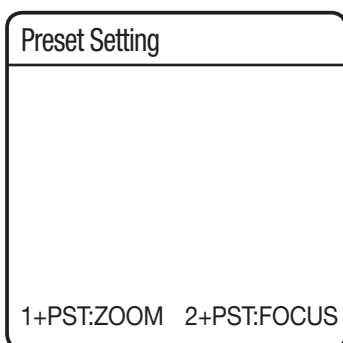

## ◆ PTZF Setting

1. If you open the PTZF setup menu, you will see the following window. You can use the joystick to select a desired number.
2. Select a preset number and press ENTER. You will move to the setup screen.  
Using the joystick, adjust the location of the Pan and Tilt functions and then set the Zoom and Focus command. In Preset mode, the zooming focus can be controlled only by the zoom command.  
For switching modes, refer to the menu bar in the bottom.

Preset Setting	
Preset = 00	1 (1~255)
001 :	□□□□ □□□□ □□□□ □□□□
021 :	□□□□ □□□□ □□□□ □□□□



Preset Setting	
1+PST:ZOOM	2+PST:FOCUS

## ◆ Edit

With this feature, you can edit or save the video-related settings for each preset of the camera.

- PTZ : Recalls saved locations using the Preset Settings command.
- Focus : Refer to the section entitled Setting Up Your Camera.
- Brightness : Refer to the section entitled Setting Up Your Camera.
- Iris : Refer to the section entitled Setting Up Your Camera.
- Back Light : Refer to the section entitled Setting Up Your Camera.
- Day & Night : Refer to the section entitled Setting Up Your Camera.
- Intelligence: This will enable you to detect and trace a moving object.
- Scene Adj : You can set AGC, Stabilizer, SSSNR, SSSDR, Shutter, Sens-Up and White Balance functions. For terms related to settings, refer to the camera settings commands.

Preset	
Setting←	
Edit←	
Home Position	OFF
Execute←	
Clear←	
Status←	



Preset Edit	
Preset = 001	* (1~255)
001 :	☑□□□ □□□□ □□□□ □□□□
021 :	□□□□ □□□□ □□□□ □□□□



Preset Edit	[001]
PTZ	XXX/XXX/XXX
Focus	ONE SHOT
Brightness	050
Iris	AUTO
Back Light	OFF
Day & Night	AUTO
Intelligence	OFF
Scene Adj←	

• Detection :

Perform the intelligent motion detection.

- Detect Box: Display an object in a box that is detected to move in your specified type.
- Detect Area : You can specify a motion detection area.
- Mask Area : You can specify an exceptional area to motion detection by masking the area.  
You can set up to 4 areas, for each of which you can change the mask coordinates.
- Sensitivity : Specify the sensitivity level of the motion detection.  
The lower the level is, the stronger the sensitivity becomes.
- Detect Size : Specify the size of an object to detect on the screen.  
The higher the level is, the greater the size becomes.

Detection	
Detect Box	ON
Detect Area↵	
Mask Area↵	
Sensitivity	3
Det. Size↵	

• Fixed/Moved :

Detect if an existing object (on the screen) disappears or if an object appears from nowhere and stays for a certain time.



- In following situations, FIXED/MOVED detection may not work properly.
  - ① If multiple motions continue at random.
  - ② If a fixed object continues to move in the same position.
  - ③ If a newly appearing object conceals another object that is moving.
- 5 to 15 seconds of recognition time is required if the [Intelligence] function is activated.
- The focus mode will be controlled manually if [Intelligence] is enabled.
- The performance of [Intelligence] may be deteriorated if the camera vibrates due to unstable installation.

# setup

- Tracking :

This will detect and trace a moving object. You can use the fence function to count the moving objects. The default setting is the same as in the Detect menu, to which the Fence Position function is added.

- Fence : Specify the position and detectable direction of the line fence or area fence, depending on the fence type.

- Display: Specify the display of the fence status.
- Type : You can select one of two types for the fence LINE and AREA.
- Count : Display the number of times that an object enters or exits from the fence.



- In some cases, the Count function may have a difference between number of the detected objects and counter number.

- Fill : Specify the use of color filling on the selected fence.
- Position : Specify the position and detectable direction of the line fence or area fence, depending on the fence type.

- LINE FENCE

- SEL POS: Select a changing point from position 1 and position 2.
- X POS/Y POS: Specify the position of the changing point that you have selected in the SEL POS menu.
- DIRECTION:

DIR 1: Detect an object that moves from left to right based on the specified fence line.

DIR 2: Detect an object that moves from right to left based on the specified fence line.

DIR 1/2: Detect an object that moves in any direction of right to left or left to right based on the specified fence line.

- AREA FENCE

- SEL POS: Select a changing point from position 1 through position 4.
- X POS/Y POS: Specify the position of the changing point that you have selected in the SEL POS menu.
- DIRECTION:

IN: Detect any object that enters the specified fence area.

OUT: Detect any object that exits from the specified fence area.

IN/OUT: Detect any object that enters or exits from the specified fence area.

Tracking	
Fence	
Detect Box	ON
Detect Area	
Mask Area	
Sensitivity	3
Det. Size	



Fence	
Display	ON
Type	LINE
Count	ON
Fill	ON
Position	

Fence	
SEL POS	POS1
X POS	30
Y POS	00
Direction	DIR 1

Fence	
SEL POS	POS1
X POS	20
Y POS	10
Direction	IN



◆ **Preset Name Setting**

Using this function, you can add names to preset locations up to 12 characters.

Once a name is entered, use the joystick and the Enter key to perform the Set command and save the name.

Main Menu	
Camera Setting←	↵
Sequence Setting←	↵
P/T Setting←	↵
OSD Setting←	↵
Alarm Setting←	↵
Initialize←	↵
Password Setting←	↵
Status←	↵



OSD Setting	
Camera ID	ON
Camera Name←	↵
Preset Number	ON
Preset Name←	↵
....	



Preset Name	
On/Off	OFF
Edit←	↵



Preset Name	
Preset = 001* (1~255)	
001 :	☐☐☐☐ ☐☐☐☐ ☐☐☐☐ ☐☐☐☐
021 :	☐☐☐☐ ☐☐☐☐ ☐☐☐☐ ☐☐☐☐



Preset Name [                    ]	
A B C D E F G H I J K L M	
N O P Q R S T U V W X Y Z	
a b c d e f g h i j k l m	
n o p q r s t u v w x y z	
1 2 3 4 5 6 7 8 9 0 ( )	
[ ] - / ☐ * ! ? , .	
BACK SPACE CLR SET	

# setup

## ◆ Home Position

Sets one of the currently configured preset positions as the home position.

The Home Position option is the location to move after booting.

Preset	
Setting←↓	
Edit←↓	
Home Position	OFF
Execute←↓	
Clear←↓	
Status←↓	

## ◆ Execute

Recalls a saved preset location.

While in Sequence mode operation, the actual movement can be slower than the specified when moving the camera in the direction of Pan and Tilt at the same time.

Preset	
Setting←↓	
Edit←↓	
Home Position	OFF
Execute←↓	
Clear←↓	
Status←↓	

## ◆ Clear

Deletes the selected preset location.

Preset	
Setting←↓	
Edit←↓	
Home Position	OFF
Execute←↓	
Clear←↓	
Status←↓	

## ◆ Status

Opens a map of saved preset locations.

An area saved as a preset location is displayed with the 'V' icon.

Preset Status	
001 :	▣▣▣▣ ▣▣▣▣ ▣▣▣▣ ▣▣▣▣
021 :	▣▣▣▣ ▣▣▣▣ ▣▣▣▣ ▣▣▣▣
041 :	▣▣▣▣ ▣▣▣▣ ▣▣▣▣ ▣▣▣▣
061 :	▣▣▣▣ ▣▣▣▣ ▣▣▣▣ ▣▣▣▣
081 :	▣▣▣▣ ▣▣▣▣ ▣▣▣▣ ▣▣▣▣
101 :	▣▣▣▣ ▣▣▣▣ ▣▣▣▣ ▣▣▣▣
121 :	▣▣▣▣ ▣▣▣▣ ▣▣▣▣ ▣▣▣▣

Preset Status	
141 :	▣▣▣▣ ▣▣▣▣ ▣▣▣▣ ▣▣▣▣
161 :	▣▣▣▣ ▣▣▣▣ ▣▣▣▣ ▣▣▣▣
181 :	▣▣▣▣ ▣▣▣▣ ▣▣▣▣ ▣▣▣▣
201 :	▣▣▣▣ ▣▣▣▣ ▣▣▣▣ ▣▣▣▣
221 :	▣▣▣▣ ▣▣▣▣ ▣▣▣▣ ▣▣▣▣
241 :	▣▣▣▣ ▣▣▣▣ ▣▣▣▣

Preset	
Setting←↓	
Edit←↓	
Home Position	OFF
Execute←↓	
Clear←↓	
Status←↓	

## Swing SEQ

The Swing function commands the camera to move between 2 selected locations, monitoring the route.

- **Pan Swing :**  
Activates the Pan function for the Swing operation.
- **Tilt Swing :**  
Activates the Tilt function for the Swing operation.
- **P/T Swing :**  
Activates both the Pan and Tilt functions for the Swing operation.
- **Swing Setting/Execute/Clear**  
Each of the Swing menus have sub menus with the settings.

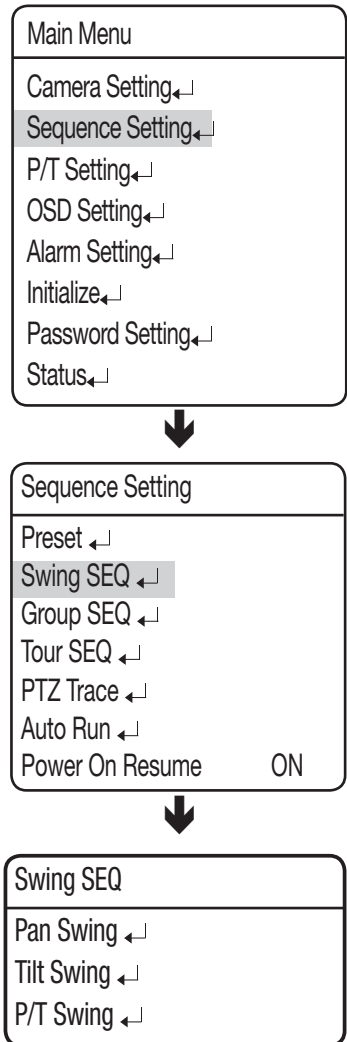
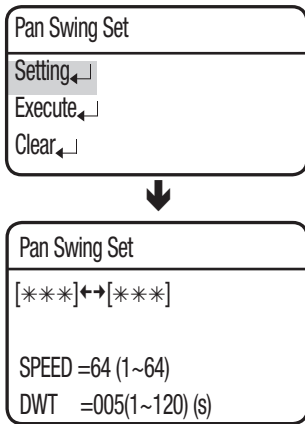

Select 2 preset locations by using the joystick.

Speed indicates the camera's movement speed. DWELL TIME indicates the camera's duration of stay at a preset location.

- Execute: Executes the Swing operation.
- Clear: Deletes data in the Swing memory.

- While in Sequence mode operation, the actual movement can be slower than the specified when moving the camera in the direction of Pan and Tilt at the same time.

## Group SEQ

Selecting Group SEQ recalls a group of multiple preset locations in a consecutive manner. Up to 6 groups can be defined and up to 128 presets can be memorized for each group.

- **Setting :**

Using the joystick, enter desired preset numbers into the PSET section. DWT indicates the camera's duration of stay at a preset location.

The speed is adjusted in 64 levels.

Group SEQ 1			
NO	PSET	DWT(s)	SPD
001	***	003	64
002	***	003	64
003	***	003	64
004	***	003	64
005	***	003	64
006	***	003	64
007	***	003	64

- **Execute :**

Executes the group operation.

- **Clear :**

Deletes the selected group.



- About 8 seconds of recognition time is required if [Intelligence] of the preset is activated from the Group menu.
- For a proper operation of [Intelligence], set [Time (sec)] of the Group menu to more than 8 seconds.

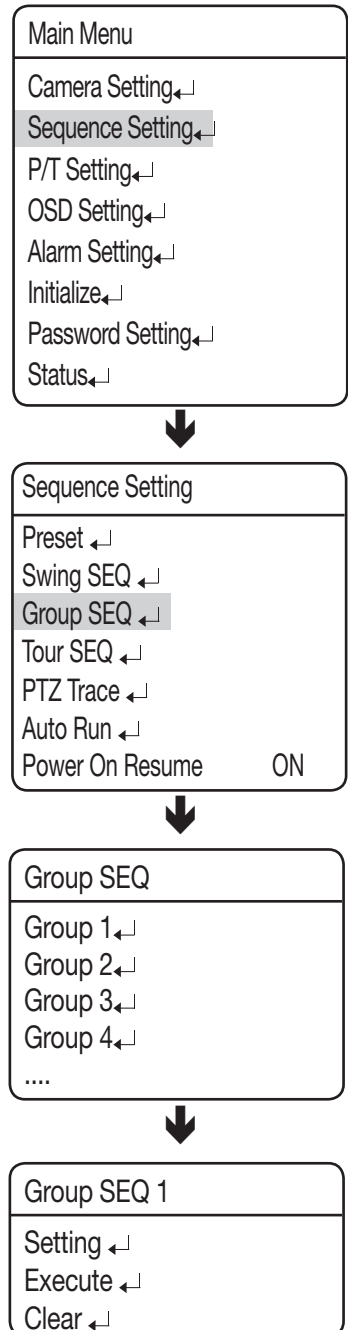

## Tour SEQ

Selecting Tour SEQ recalls groups of preset locations in a consecutive manner. Up to 6 groups can be listed for this function.

- **Setting :**

Selecting the Settings menu brings up the following screen. Using the joystick, you can enter desired group numbers to the Group section. DWT indicates the camera's standby time before a new group is recalled.

Tour SEQ		
NO	GROUP	DWT(s)
01	*	003
02	*	003
03	*	003
04	*	003
05	*	003
06	*	003

- **Execute :**

Executes the group operation.

- **Clear :**

Deletes the selected group.

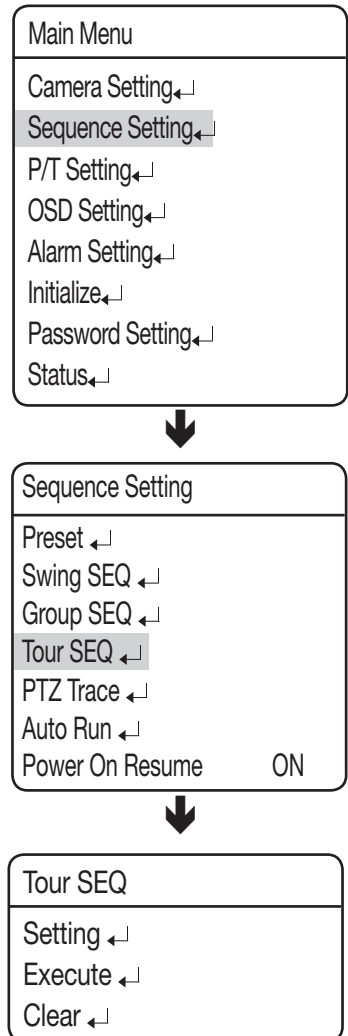

## PTZ Trace

Maximum 4 patterns of the manual operation paths (for Pan, Tilt, Zoom and Focus) are memorized and replayed.

- **Replay :**

Replays a route saved by the Trace function.

- **Replay Once :**

Replays a saved Trace route once.

- **Memorize :**

The time for storing the event differs depending on the complexity of PTZ operations of your choice.

When the memory becomes full, saving will be automatically terminated.

When saving continues for more than 2 minutes, the saving job will be automatically terminated.

While in saving mode, the saving job may be terminated using the Menu (OSD entry) key.

※ Using other protocols

Protocol	Representative Model	Stop saving the trace
PELCO-D/P	KDB300A	Ack, Iris Open
SAMSUNG-E	SSC-5000	OSD ON, Iris Open
PANASONIC	WV-CU161C	OSD ON
VICON	V1300X-DVC	Iris Open
HONEYWELL	HTX-3000	Iris Open
AD		OSD ON, Iris Open
GE	KTD-405	Iris Open
Bosch		Iris Open

- **Clear :** Deletes a saved Trace route.

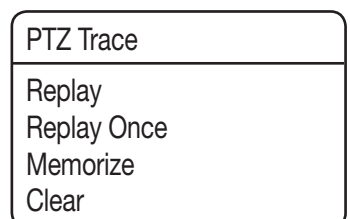
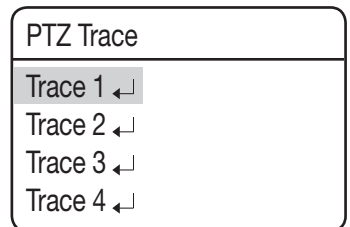
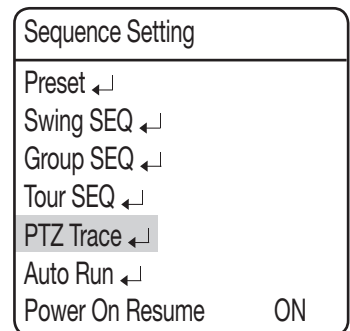
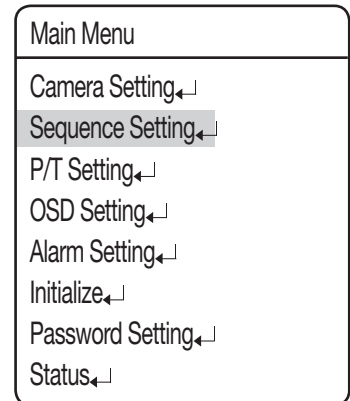

## Auto Run

If there is no controller operation by the user for a certain time, the sequence operation designated by the user will be executed.

- **Mode :**
  - HOME : Auto run Home Position (Refer to the Preset Menu.)
  - PRESET : Auto run a selected preset number.
  - SWING : Auto run a selected Swing mode.
  - GROUP : Auto run a selected Group mode.
  - TOUR : Auto run a selected Tour mode.
  - TRACE : Auto run a selected trace mode.
  - A.PAN : Auto run a 360-degree pan. To activate the panning command, you need to set up the camera's tilt angle and auto pan speed manually.
  - SCHEDULE : Execute Auto Run on the selected day of the week.
  
- **Time :**  
 Enables setting up an Auto Run duration. (The duration can be 5~30 seconds, or 1~5 minutes.)

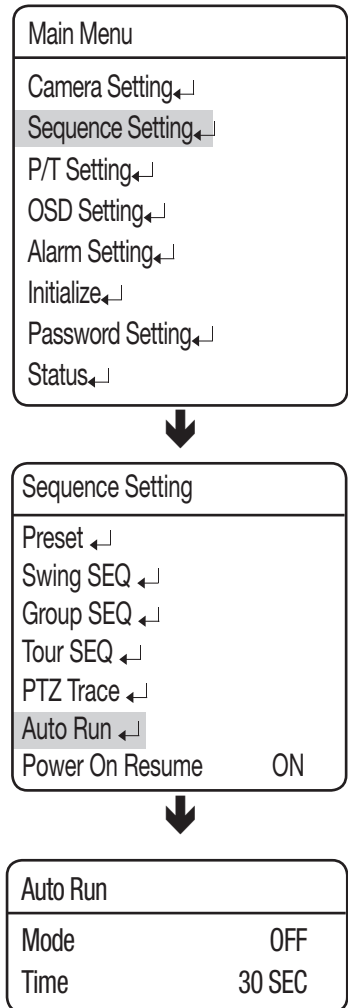

## ◆ Schedule

Schedule enables you to schedule a sequencing action by day and time.

### ● Select Day :

At Auto Run, select SCHEDULE to set up each day of the week, as shown on the side picture. Select a day, change to ON, and then press Enter.

### ● Select Time :

When turning ON a day, a timetable appears as shown on the side picture. (Up to 6 timelines can be selected for a day.) Select the beginning time and sequencing action to schedule the action.

Auto Run	
Mode	SCHEDULE←↵
Time	30SEC



AutoRun Mode Set	
Sunday	ON←↵
Monday	OFF
Tuesday	OFF
Wednesday	OFF
Thursday	OFF
Friday	OFF
Saturday	OFF



Schedule Set			
No	START	SEQ	No
1	09:00	HOME	
2	00:00	OFF	
3	00:00	OFF	
4	00:00	OFF	
5	00:00	OFF	
6	00:00	OFF	
Clear←↵			

## Power On Resume

### ● Power On Resume :

This is useful when the power is disconnected and reconnected due to power failures or other power interruptions.

If the camera was performing a sequence action prior to a power disconnection, the camera automatically resumes the action when the power is reconnected.

Main Menu	
Camera Setting←↵	
Sequence Setting←↵	
P/T Setting←↵	



Sequence Setting	
Preset ←↵	
Swing SEQ ←↵	
Group SEQ ←↵	
Tour SEQ ←↵	
PTZ Trace ←↵	
Auto Run ←↵	
Power On Resume	ON



## P/T Setting

### Pan/Tilt Limit

The moving ranges in the Pan/Tilt directions can be limited.

● **Position :**

Selecting the Position menu brings up the following screen if it is for the Pan Limit setting. Move the joystick left and right to select a movement range from the starting point to the end.

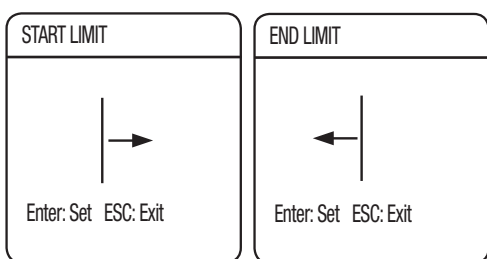

The following picture shows the Tilt Limit setting.

Move the joystick left and right to select a movement range from the starting point to the end.

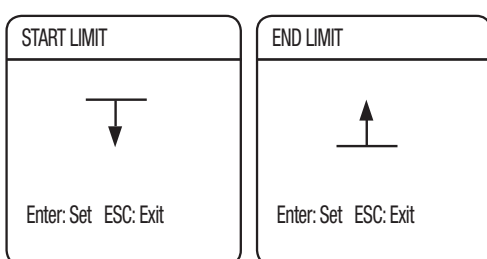

● **Activation :**

Sets the configured Pan/Tilt Limit function to use or not.

- 

 With its maximum wide angle, the camera's field of view may be blocked if reached the both ends of tilting angle. In such cases, the amount of blocked portions at both ends may be different.

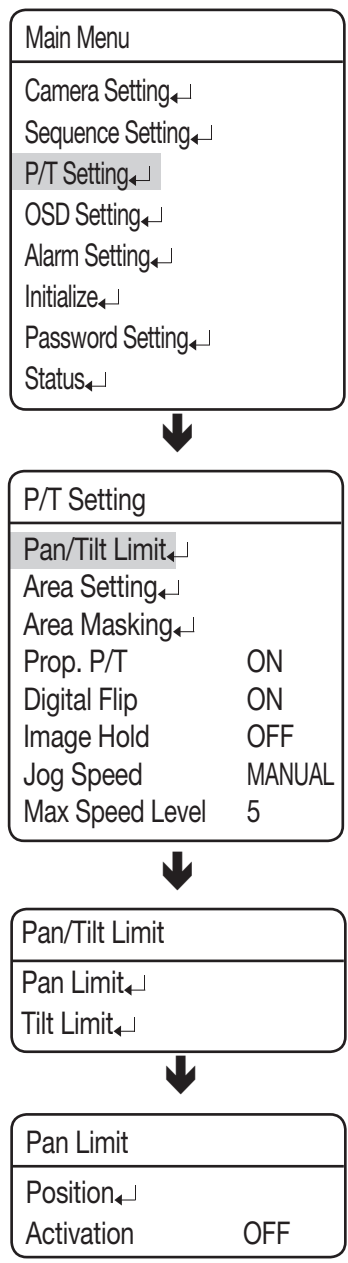

## Area Setting

The Area Setting menu enables selecting certain locations in the course of the Pan and Tilt operation, and then display the areas with the OSD (On Screen Display) texts when the camera passes through them. Up to 12 areas can be selected.

- **Area Name :**

You can add names to selected areas. Names can be up to 12 characters and can be entered via the joystick and the Enter key. Once a name is entered, use the joystick and the Enter key to perform the Set command and save the name.

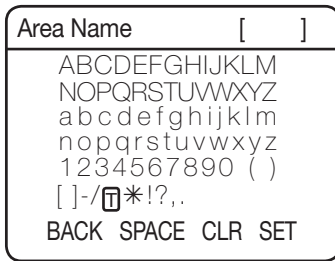

- **Position :**

As shown in the picture below, move the joystick to select the upper left corner and lower right corner of an area.

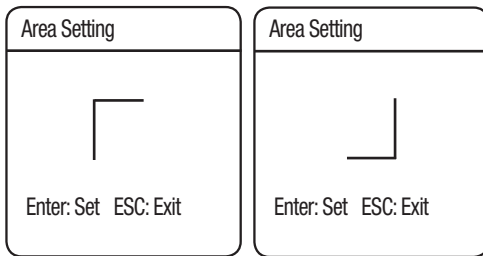

The effective positioning range is between -45° and 40° in the tilting angle at the zoom factor of 1x.

- **Activation :**

Cancels or activates the display function of selected areas.

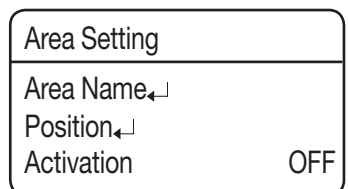
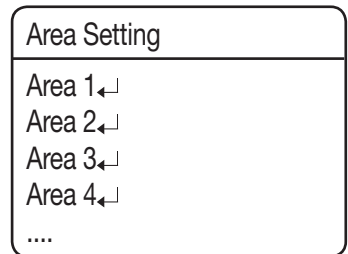
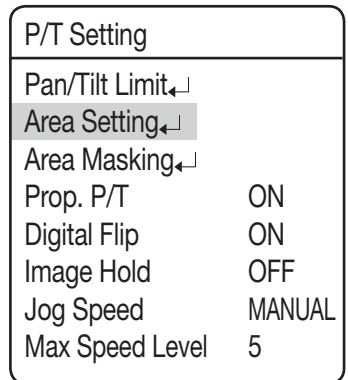
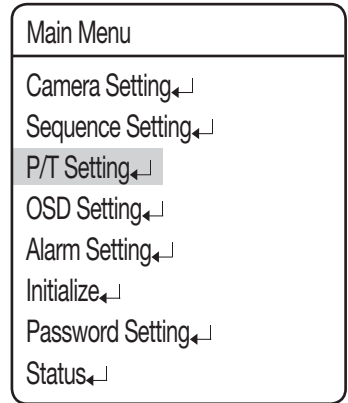

## Area Masking

If a monitoring location includes a highly private area, the area can be selectively excluded from monitoring.

- **Position :**

As shown in the picture below, move the joystick to select the upper left corner and lower right corner of an area.

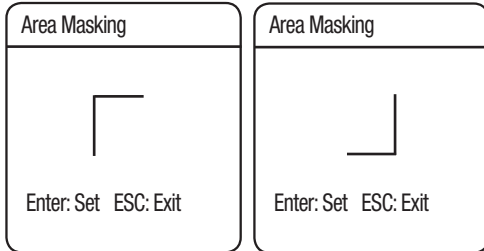

Use the joystick in four directions to specify the masks that you want to exclude from the area masking.

- **Activation :**

Activate or deactivate the display of specified masks.

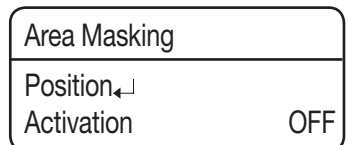
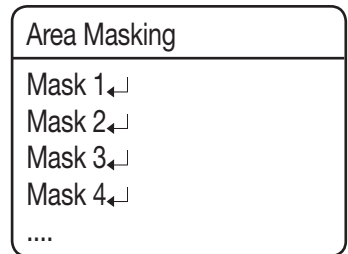
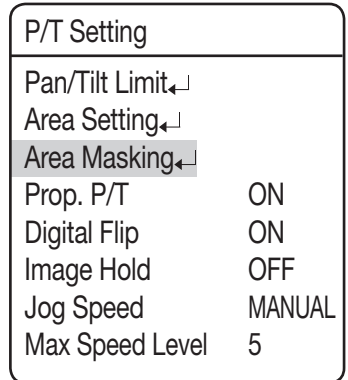
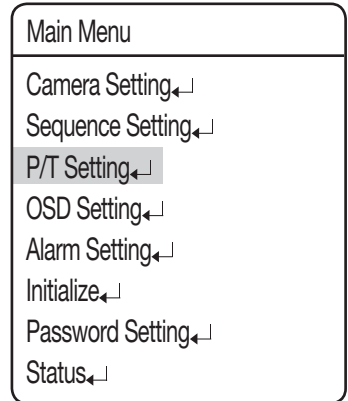

# setup

---

## Prop. P/T

---

This commands the camera to change the Pan and Tilt speed automatically according to the current zoom ratio. Moving the joystick clockwise (Tele) slows down and counterclockwise (Wide) accelerates the Pan and Tilt speed, allowing detailed adjustments. Turning this “Off” executes the function the optical 1x zoom speed regardless of how far the lens is zoomed in.

Main Menu	
Camera Setting	↵
Sequence Setting	↵
<b>P/T Setting</b>	↵
OSD Setting	↵
Alarm Setting	↵
Initialize	↵
Password Setting	↵
Status	↵



P/T Setting	
Pan/Tilt Limit	↵
Area Setting	↵
Area Masking	↵
<b>Prop. P/T</b>	ON
Digital Flip	ON
Image Hold	OFF
Jog Speed	MANUAL
Max Speed Level	5

## Digital Flip

Digital Flip is useful to monitor a moving object or a person passing directly under the camera.

When the object passes straight under the camera, tilting can be traced up to the opposite tilting area without the need of the pan operation. The reverse screen that occurs when the object gets through the 90-degree point will be corrected in digital processing.

- 0° → 180° : Image flip at the 93-degree point
- 180° → 0° : Image flip at the 87-degree point

Main Menu	
Camera Setting	↵
Sequence Setting	↵
P/T Setting	↵
OSD Setting	↵
Alarm Setting	↵
Initialize	↵
Password Setting	↵
Status	↵



P/T Setting	
Pan/Tilt Limit	↵
Area Setting	↵
Area Masking	↵
Prop. P/T	ON
Digital Flip	ON
Image Hold	OFF
Jog Speed	MANUAL
Max Speed Level	5

## Image Hold

---

This will display the preset video in still images until the orientation of the camera reaches the preset position at a group or tour movement.

This is useful if you want to monitor the video while preventing a possible visual distraction of the observer.

Main Menu	
Camera Setting	←
Sequence Setting	←
P/T Setting	←
OSD Setting	←
Alarm Setting	←
Initialize	←
Password Setting	←
Status	←



P/T Setting	
Pan/Tilt Limit	←
Area Setting	←
Area Masking	←
Prop. P/T	ON
Digital Flip	ON
Image Hold	OFF
Jog Speed	MANUAL
Max Speed Level	5

## Jog Speed

You can adjust the speed of the pan or tilt operation. The pan/tilt speed changes according to the tilt of the joystick, or you can control the operation in a fixed speed.

- **MANUAL :**

The pan/tilt speed depends on how much the joystick of the controller is tilted. The more the joystick is tilted, the faster the operation is performed.

- **30/35/40/45/50/55/60 :**

The pan/tilt operation will be performed at the selected speed; the greater the number is, the faster the operation is performed.

However, the speed at each level may differ according to the zooming status, and depending on the use of synchronized zooming.

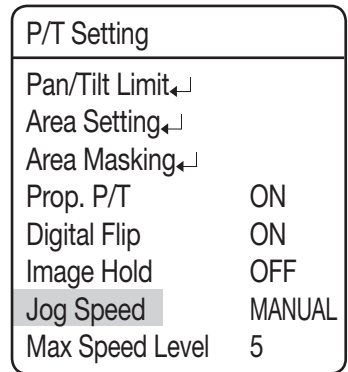
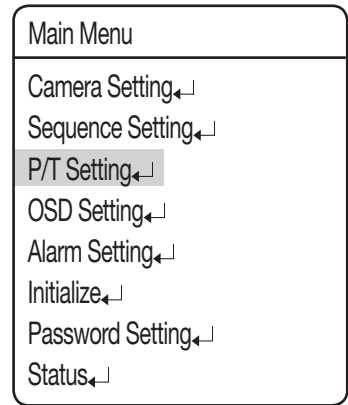

## Max Speed Level

Adjusts the maximum speed of Pan and Tilt while performing the Preset and Sequencing actions.

● 1~5 :

Pan and Tilt operations can be set up to 500°/ sec.

※ Preset speed for each level

Level	Speed (Unit: °/sec)
5	500
4	450
3	400
2	360
1	300

 ■ The Pan/Tilt speed will be reduced at below -40°.

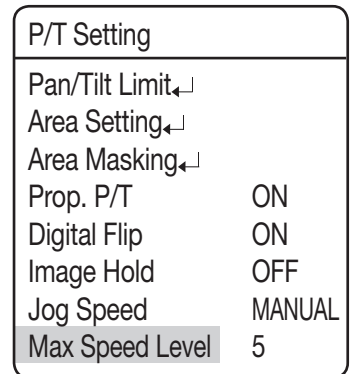
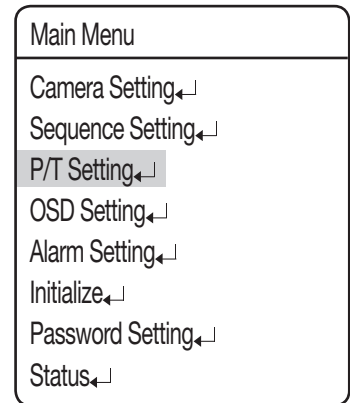



## OSD SETTING

In this menu, you can configure the OSD (On Screen Display) settings.

- **Camera ID :**

Displays or hides Camera ID in the upper left of the screen.

- **Camera Name :**

Add a name to the camera. (see the top note on page 78 for more information.)

- **Preset Number :**

Displays or hides Preset Numbers on the screen.

- **Preset Name :**

Add names to preset locations. (see the top note on page 78 for more information.)

- **Seq. Status :**

Displays or hides the status of a sequence action that is in progress.

- **Area Name :**

Displays or hides the Area Name for the Area Settings on the screen.

- **PTZ Position :**

Displays or hides the status of the Pan, Tilt, and Zoom operation that is in progress.

- **Language :**

Enables changing the system language. This camera supports ENGLISH, FRENCH, GERMAN, SPANISH, ITALIAN, PORTUGUES, POLISH, RUSSIAN, CZECH, TURKISH, KOREAN, JAPANESE.

- **Others**

- Direction : Indicates the current angle of the camera:
  - East, West, South, North, Southeast, Southwest, Northeast, or Northwest.
  - Set North Dir. : Specify the azimuth of the north manually.
- Clock Setting: You can specify the time information manually that will be displayed on the screen. This will synchronize with Sequence so that you can set it to activate on a specific time and date.
  - Display: Specify the use of time display on the screen.
  - Date Format: Specify the date format. (DD/MM/YYYY, MM/DD/YYYY)
  - Set Date: Enter a desired date manually.
  - Time Format: Specify the time format. (24hr / 12hr)
  - Set Time: Specify the time manually.

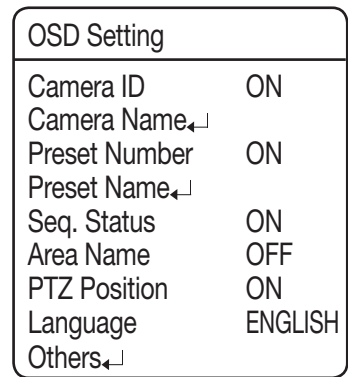
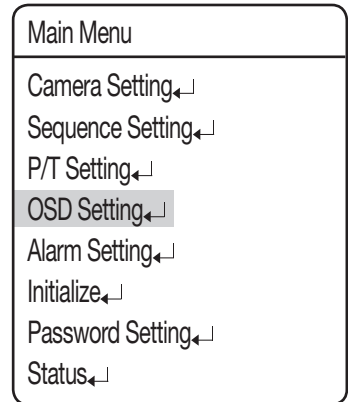

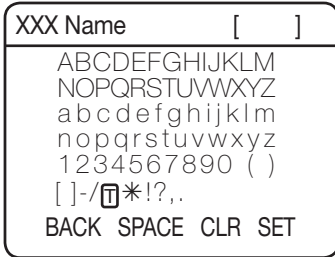

- When selecting the Camera Name and Preset Name, the screen displays the Left keypad.
- Names can be up to 12 characters and can be entered via the joystick and the Enter key. Once a name is entered, use the joystick and the Enter key to perform the Set command and save the name.

## ALARM SETTING

### Alarm Enable

- ON/OFF :**  
Enables or disables the Alarm function.

### Alarm Input

- MOD**  
Enables selecting an Alarm Input method.

- NO (Normally Open)

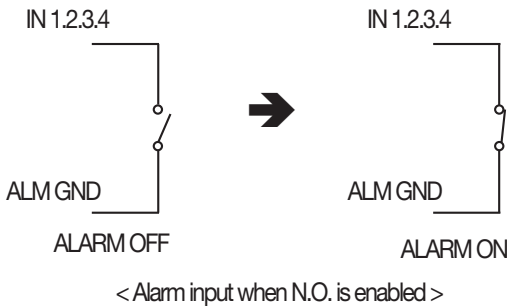

- NC (Normally Closed)

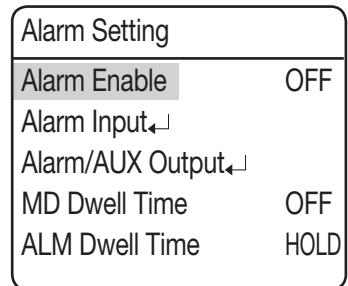
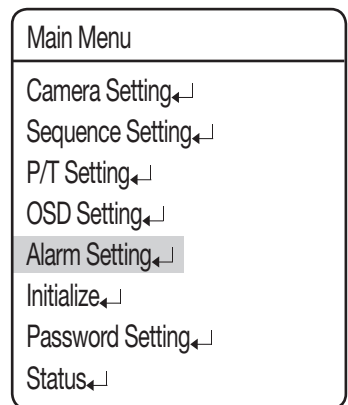
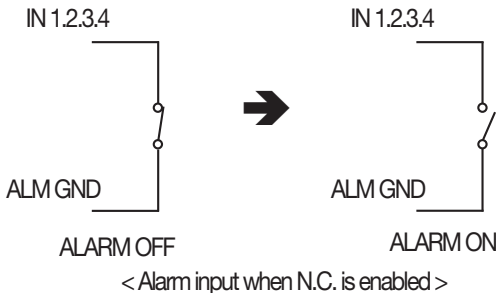

ALM	MOD	P	SEQ.	NO
IN1	OFF	1	OFF	
IN2	OFF	2	OFF	
IN3	OFF	3	OFF	
IN4	OFF	4	OFF	



- As shown in the picture above, the Alarm Input must be entered with the Open or Closed switch signals. Supplying power without entering the signals may damage the product.

● **P(Priority) :**

Set the priority of Alarm Inputs. If more than one alarm is simultaneously activated, the alarm with the highest priority activates before the others.

● **SEQ. :**

Enables setting up a sequence action for the camera in response to an alarm. You can configure the settings of: HOME/PRESET/SWING/GROUP/TOUR/TRACE/A.PAN/OFF

## Alarm/AUX Output

● **Setting 1, 2 :**

Enables selecting an Alarm Output method.

- DETECT MODE : Displays the alarm input ports (1~4) and the motion detection input. If you set MD Input, you can select one from: OFF/MD.
- AUX MODE : Both Alarm OUT/AUX OUT 1 and 2 are NC/NO

● **Timer 1, 2 :**

- On : Retains an alarm output for a set duration from a minimum of 1 second to a maximum of 60 minutes upon the alarm occurrence.
- MOMENTARY : The output operation will last until an alarm/AUX event is released since its occurrence.
- The Alarm/AUX output system is equipped with a relay circuit, whose output port operates as below: (based on "NO")

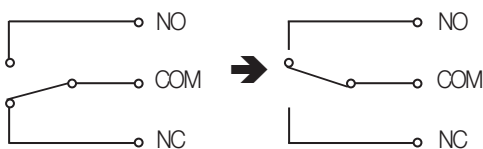

Alarm Out OFF

Alarm Out ON

● **OUT Off 1, 2 :**

- Output of an alarm/AUX event can be forcibly terminated when it occurred.

Main Menu	
Camera Setting	↵
Sequence Setting	↵
P/T Setting	↵
OSD Setting	↵
Alarm Setting	↵
Initialize	↵
Password Setting	↵
Status	↵



Alarm Setting	
Alarm Enable	OFF
Alarm Input	↵
Alarm/AUX Output	↵
MD Dwell Time	OFF
ALM Dwell Time	HOLD



Alarm/AUX Output	
Setting 1	DETECT MODE ↵
Setting 2	DETECT MODE ↵
Timer 1	OFF
Timer 2	OFF
Out Off 1	
Out Off 2	



- Connecting the power connector and GND incorrectly to the NC/NO and COM ports may cause a short circuit and fire, damaging the camera.
- The max voltage and capacity of the Alarm OUT/AUX OUT ports are 30VDC/2A and 24VAC/2.5A. Operating the camera beyond the capacity may decrease the camera's lifespan and damage it.

## MD Dwell Time

---

When Motion Detection under the Preset Edit menu is selected, MD Dwell Time performs the Tour or Group function.

While the camera is performing a sequence action, if motion is detected from a selected preset location, the camera pauses the sequence action operation and starts monitoring the location instead for a duration that is set under the MD Dwell Time menu.

If the motion is no longer detectable or the duration expires, the camera aborts the monitoring operation and then resumes the sequence action.

Main Menu	
Camera Setting	←
Sequence Setting	←
P/T Setting	←
OSD Setting	←
Alarm Setting	←
Initialize	←
Password Setting	←
Status	←



Alarm Setting	
Alarm Enable	OFF
Alarm Input	←
Alarm/AUX Output	←
MD Dwell Time	OFF
ALM Dwell Time	HOLD

## ALM Dwell Time

---

You can specify the time of sequence operation that will be activated if an event occurs from the alarm input.

- **SET:**  
The sequence operation will proceed for a specified time.
- **HOLD:**  
The sequence operation will be maintained until the user deactivates it.

# INITIALIZE

- **Power On Reset :**

Restarts the camera.

- **Factory Default Set :**

Enables resetting the camera to its factory default settings. When the mode is selected, all custom data such as preset locations is deleted from the camera.

Use this function if it is necessary to reset the settings of the camera.

[Current Time], [Language] and [Fan Life] values maintain the current values rather than the default values.

- **Camera Default Set :**

Reset the zoom module of the camera to the factory default. Use this if you want to return the camera settings of such as Exposure or Backlight to the factory default.

- **Auto Refresh :**

Optimizes the settings of the electric circuits and component parts of the camera on a regular basis.

This is useful for maintenance purpose, especially when the camera faces a specific light source, or if the camera settings are not maintained properly due to an extended time of recording while rotating the camera in four directions.

- Off, 1~7 Days : Selecting Off disables Auto Refresh and selecting 1~7 Days automatically executes it after 1~7 days has passed.

- ※ Auto Refresh takes about 10 seconds or less. Any sequence operation that is being performed will be stopped and resume after Auto refresh is completed.

- **Fan Life (Applied only to Environmental models) :** Enables setting the Fan Life.

- Message Display: Two months before pan life termination (1440 hours), the following warning message will appear. "Fan Life Expired. Replace the Fans"

- ▶ ON: Display the warning message. (Default)

- ▶ OFF: Do not display the warning message.

- ※ [OFF] is to hide the message, rather than to delete it. Set it back to [ON]. Then, the warning message will appear. (Only if you didn't clear the message [Message Clear])

- Message Clear: Use this if you want to delete the warning message when it pops up.

- ※ If you set [Message clear] to [On] after performing the command, no warning message will appear on the screen.

- Time Reset: Set to count the fan life again after replacing the fan. (However, this is available only after you see a warning message that the fan life has expired.)

- ※ The fan life is counted only for an actual operation so the fan can be used longer than the displayed time.

- Time Remain.(hour):

- ▶ 49000 : Remaining life of fan (unit: hour)

- ▶ The fan life will be updated when you access the [Fan Life] menu and if you press [ENTER] on the [Time Remain.(hour)] item.

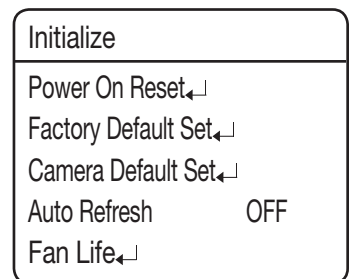
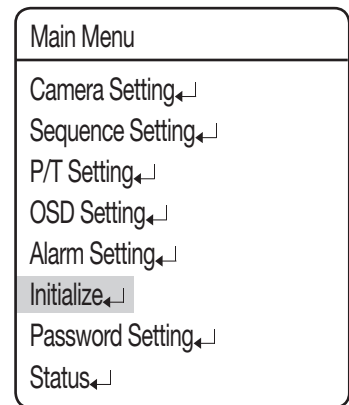

## PASSWORD SETTING

The Password feature enables you to configure a password for rebooting the camera and accessing the OSD and preventing unauthorized modification of existing camera settings.

- **On/Off :**

Enables or disables Password protection.

- **Edit Password**

Change the password; enter the current password and then a new one, consisting of 4 hexadecimal characters (0~F).

\* The default password is "0000".

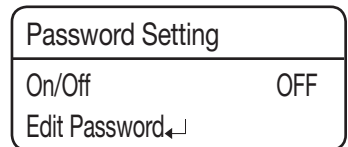
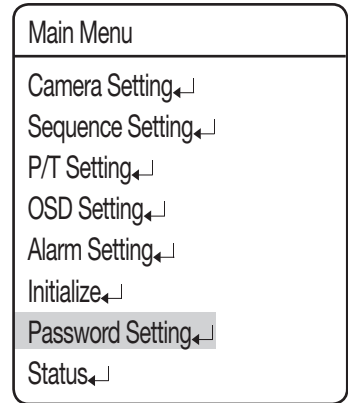

## STATUS

Displays the settings and version of the camera.

- **MODEL :**

Indicates the model name of the camera.

- **CAM VER. :**

Indicates the software version of the camera.

- **DOME VER. :**

Indicates the version of the camera control board.

- **PROTOCOL :**

Indicates the status of the current protocol.

- **DOME ID :**

Dome Camera ID

- **CONTROLLER :**

Indicates the settings of the current communications mode.

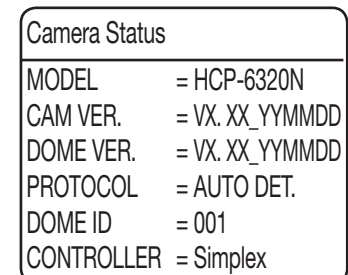
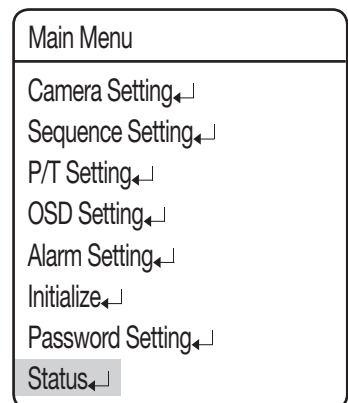

# troubleshooting

## TROUBLESHOOTING

If the product does not function properly, please see the below for trouble shooting.

Problem	Cause and Solution
Controller does not work.	▶ Check if the camera and peripheral devices are properly connected.
	▶ Verify the setups of ID, protocol, and baud rates.
No picture is displayed on monitor.	▶ Check if power cable is securely connected to the camera and the monitor. Check if the video cable is properly connected. Consult the operation manual of the system controller connected to the camera.
	▶ Check if the iris of the lens is closed. Adjust the menu for the iris of the lens.
	▶ Check the camera's fixed shutter speed. Adjust the camera's shutter menu.
The picture is too dark/bright.	▶ Check the camera's Brightness menu. Adjust the camera's Brightness menu.
The monitor displays a white image.	▶ Check if the iris of the lens is open. Adjust the menu for the iris of the lens.
Picture is out of focus.	▶ Check if the dome cover or the camera lens is dirty or smudged. If it is, clean the dirt off.
	▶ Verify the distance between the camera and the subject, as well as the subject's surroundings. Camera may have difficulty focusing on a subject against a white background.
	▶ If Auto Focusing is having difficulty focusing on a particular subject, set Focus Mode to Manual and adjust the focus by yourself.
	▶ Use the camera's reset menu to restore the camera settings in order to default.
	▶ Adjust Sharpness level.
Digital noise appears in picture.	▶ Check if the video cable is properly connected.
	▶ Make sure that the power cable and video cable do not exceed the recommended maximum lengths.
	▶ Adjust Sharpness level.

# troubleshooting

Problem	Cause and Solution
Picture's colors are not good.	▶ Check the White Balance.
	▶ Adjust Color Menu in Image Adj.
	▶ Check if the dome cover or the camera lens is dirty or smudged. If it is, clean the dirt off.
The picture is flickering.	▶ Check if the camera is pointing directly at a fluorescent light or sunlight. If so, change the camera's direction to remove the flickering.
Afterimages appear in picture.	▶ Check Sens-Up settings.
Camera switches between color and B&W modes frequently.	▶ Adjust Duration and Dwell Time in Day & Night menu.
Pan, tilt, zoom, and/or focus do not work.	▶ Check if power cable is securely connected to the camera and the monitor. Check if the video cable is properly connected. Consult the operation manual of the system controller connected to the camera.
	▶ Check if Pan Limit and/or Tilt Limit are set. If so, remove the limit(s).
	▶ A motor or the lens may be overheated. If so, contact your service personnel or system provider for assistance.
The camera's position differs from the position defined in a preset.	▶ This phenomenon may happen, since the motors have a margin error of $\pm 0.1^\circ$ .
Sequence configuration of the camera does not work.	▶ Check if Preset or another operation mode has been set. ▶ Check the Auto Refresh settings.
The upper side of the picture is dark when the camera is on the horizontal reference point.	▶ You are seeing the camera's internal cover. The camera is functioning normally.
Camera suddenly turns on or moves to a preset position by itself.	▶ Check the Auto Run settings. Auto Run puts a camera through a predefined action sequence if the user does not use the Controller to operate the camera for a certain period of time.
	▶ Check the Auto Refresh settings. Auto Refresh optimizes the camera's circuitry and components according to a predefined schedule.



Problem	Cause and Solution
<b>I turned on the power, but the camera didn't start running. (HCP-6320H Only)</b>	<ul style="list-style-type: none"> <li>▶ Please check the environment temperature; the camera may not operate properly if it has been left at temperatures lower than -50° for a prolonged duration.</li> </ul>
	<ul style="list-style-type: none"> <li>▶ The motor may malfunction at temperatures lower than -20°; please turn on the camera in Standby mode instead of [Initialize].</li> </ul>
	<ul style="list-style-type: none"> <li>▶ When the internal temperature is above -20°C at the time power is supplied, the "Wait to warm up (xx Left)" message will disappear and the product will enter normal operation state upon rebooting. The sequencing operation will be restricted, allowing only manual P/T operation.</li> </ul>
<b>I can't see the screen. (The screen is black.)</b>	<ul style="list-style-type: none"> <li>▶ When the camera's internal temperature drops down to -20° or lower, it becomes unable to transmit video signals and may cause a black screen.</li> </ul>
	<ul style="list-style-type: none"> <li>▶ A black screen does not indicate camera breakage; it resets itself and starts displaying video again once its internal temperature reaches -20° or higher.</li> </ul>
<b>The camera stops in the Initialize mode and won't proceed to the next mode.</b>	<ul style="list-style-type: none"> <li>▶ The motor may malfunction at temperatures lower than -20°; please turn on the camera in Standby mode instead of [Initialize].</li> </ul>
<b>I can use the controller, but I can't activate the Sequence command.</b>	<ul style="list-style-type: none"> <li>▶ When the camera's internal temperature is between -10° to -20°, the motor may malfunction, limiting the use of the Sequence and Turbo commands.</li> </ul>
	<ul style="list-style-type: none"> <li>▶ Once the internal temperature reaches -10° or higher, all Sequence modes become reactivated normally.</li> </ul>
<b>I can't get rid of this message from the screen: " Fan life Expired. Replace the Fans."</b>	<ul style="list-style-type: none"> <li>▶ Please make sure to "Clear" the message from the screen.</li> </ul>
<b>The camera suddenly resets itself while displaying the black screen.</b>	<ul style="list-style-type: none"> <li>▶ Such symptoms may occur if the camera's temperature increases from -20° or lower to -20° or higher.</li> </ul>
<b>"Auto Refresh(Wait)" appears and the camera reboots.</b>	<ul style="list-style-type: none"> <li>▶ Such symptoms may occur if the camera's temperature increases from -10° or lower to -10° or higher to prevent the malfunction of motor.</li> </ul>
<b>"Please Check Heater System" appears.</b>	<ul style="list-style-type: none"> <li>▶ The heater may malfunction. Turn off the camera and call where you bought.</li> </ul>

# troubleshooting

---

## Check the Power cord's by periods

- The Power cord's coating has been damaged.
- The power cord is hot to touch when the product is in operation.
- The power cord gets hot after being folded or pulled on.

Continuing to use the product when its power cord is damaged constitutes an electrical and fire hazard. The power plug must be removed from the outlet immediately, and a qualified service personnel or your system provider should be contacted for assistance.

# product specifications

## PRODUCT SPECIFICATIONS

Model		HCP-6320	HCP-6320H
Video	Imaging Device	1/2.8" 2.38M CMOS	
	Total Pixels	1952(H) x 1116(V), 2.18M	
	Effective Pixels	1944(H) x 1104(V), 2.14M	
	Scanning System	Progressive	
	Min. Illumination	Color : 0.3 Lux (1/30sec, F1.6, 50IRE) , 0.005 Lux(2sec, F1.6, 50IRE) B/W : 0.03 Lux (1/30sec, F1.6, 50IRE), 0.0005 Lux(2sec, F1.6, 50IRE) Color : 0.2 Lux (1/30sec, F1.6, 30IRE), 0.003 Lux(2sec, F1.6, 30IRE) B/W : 0.01 Lux (1/30sec, F1.6, 30IRE), 0.0001 Lux(2sec, F1.6, 30IRE)	
	S / N Ratio	50dB	
	Video Out	BNC (AHD)	
Lens	Focal Length (Zoom Ratio)	4.44 ~ 142.6mm(Optical 32X)	
	Max. Aperture Ratio	F1.6 (Wide) / F4.4 (Tele)	
	Angular Field of View	H : 62.8°(Wide) ~ 2.23°(Tele) / V : 36.80°(Wide) ~ 1.26°(Tele)	
	Min. Object Distance	Wide 1.5m ,Tele 2m	Wide 1.4m ,Tele 1.9m
	Focus Control	Auto / Manual / One Push	
	Lens Type	DC Auto Iris	
	Mount Type	Board-in type	
Pan/Tilt/Rotate	Pan Range	360° Endless	
	Pan Speed	Preset : 700°/sec, Manual : 0.024°/sec ~200°/sec	
	Tilt Range	210°(-15° ~195°)	
	Tilt Speed	Preset : 700°/sec, Manual : 0.024°/sec ~200°/sec	
	Preset	255ea	
	Preset Accuracy	±0.2°	
	Azimuth	Yes (E/W/S/N/NE/SE/NW/SW OSD)	

# product specifications

Model		HCP-6320	HCP-6320H
Operational	Camera Title	Off / On (Displayed up to 12 characters)	
	Day & Night	Auto (ICR) / Color / B/W	
	Backlight Compensation	Off / BLC / HLC	
	Wide Dynamic Range	120dB	
	Contrast Enhancement	SSDR (Samsung Super Dynamic Range) (Off / On)	
	Digital Noise Reduction	SSNRIII (2D+3D Noise Filter) (Off / On)	
	Digital Image Stabilization	Off / On	
	Defog	Auto/Manual/Off	
	Motion Detection	Off / On (1ea Rectangle zone)	
	Privacy Masking	Off / On (12 Zones of Rectangle zone)	
	Gain Control	Off / Low / Middle / High	
	White Balance	ATW / AWC / Manual / Indoor / Outdoor / Mercury / Sodium	
	Electronic Shutter Speed	ESC / AUTO/MANUAL	
	Digital Zoom	16x	
	Digital Flip	Off / On	
	Intelligent Video Analytics	Virtual Line, Enter/Exit, Appear / Disappear	
	Alarm I/O	Input 4ea / Output 2ea (Relay)	
	Remote Control I/F	RS-485	
Protocol	RS-485: Samsung-T/E, Pelco-D/P, Panasonic, Bosch, AD, GE, Vicon, Honeywell		
Environmental	Operating Temperature / Humidity	-10°C ~ +55°C(+14°F ~ +131°F) / Less than 90% RH	24V AC: -50°C ~ +55°C (-58°F ~ +131°F) / ~ 90% RH
	Storage Temperature / Humidity	-30°C ~ +60°C (-22°F ~ +140°F) / Less than 90% RH	
	Ingress Protection	-	IP66
	Vandal Resistance	IK10 ( with SHP-3701H)	IK10

Model		HCP-6320	HCP-6320H
Electrical	Input Voltage / Current	AC24V±10%	
	Power Consumption	20W	24W Max(Heater Off), 65W Max(Heater On, AC24V)
Mechanical	Color / Material	Ivory / Plastic	Ivory / Plastic+Metal
	Dimension (WxHxD)	H218 x Ø152 mm	H293.6 x Ø223.4 mm
	Weight	1.7Kg	3.3Kg

※ The specification for this product may change without prior notice for product improvement.

# product specifications

---

## DIMENSIONS

---

❖ Indoor Model

Unit: mm (Inch)

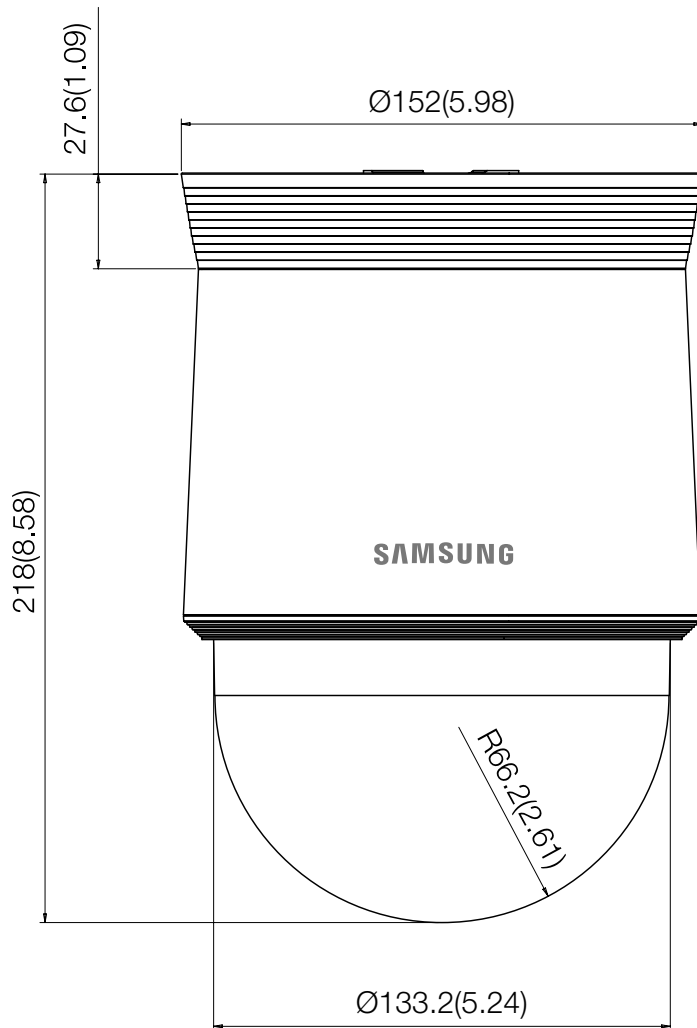

❖ Environmental Model

Unit: mm (Inch)

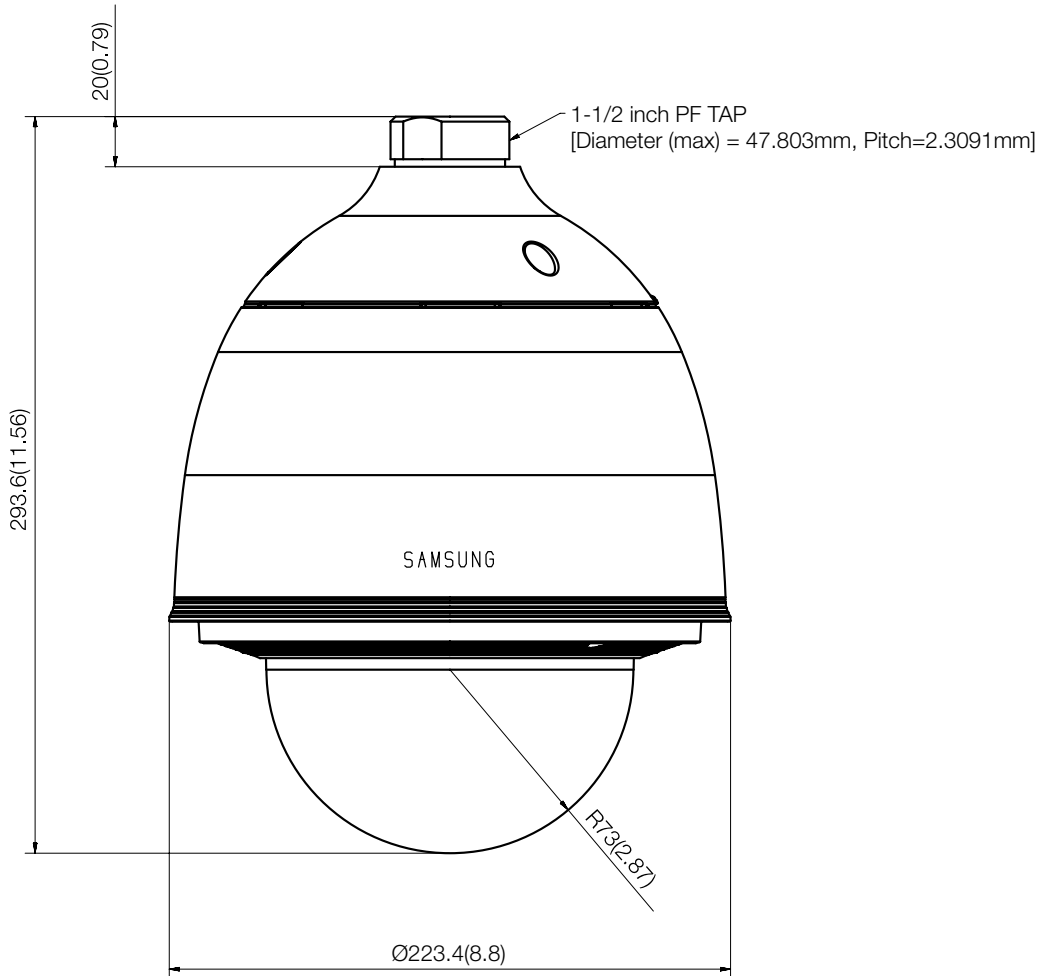

# MEMO



---

## **Head Office**

86 Cheonggyecheon-ro Jung-gu Seoul 04541 Korea

Tel +82.2.729.5277, 5254 Fax +82.2.729.5489

[www.hanwha-security.com](http://www.hanwha-security.com)

---

## **Hanwha Techwin America**

100 Challenger Rd. Suite 700 Ridgefield Park, NJ 07660

Toll Free +1.877.213.1222 Direct +1.201.325.6920

Fax +1.201.373.0124

---

## **Hanwha Techwin Europe**

2nd Floor, No. 5 The Heights, Brooklands, Weybridge, Surrey,

KT13 0NY, UK

Tel +44.1932.82.6700 Fax +44.1932.82.6701

---